



1968

The Man
Behind The
Tool Is
Switching

To

GOLDBLATT

TROWEL TRADES TOOLS®

KANSAS CITY, KANSAS 66110

subsidiary of Bliss & Laughlin Industries



Your Goldblatt magnesium hand float gives you the "just right" floating action on the slab that you demand—it comes closer to the action and feel of a wood float than any other metal. This is because we extrude the blades of our magnesium hand floats to give them a very fine, very hard, very dense grain structure. The tight grain structure also adds long life to this ultralight metal. Because of its rounded corners and broken-in face you can pick up your float and go to work with it the minute that you buy it. Fitted with a natural, straight grain wood handle, you'll find your Goldblatt magnesium hand floats easier to use, longer lasting than any others in your tool bag.



MAGNESIUM FLOATS

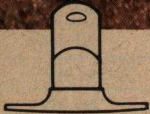

BEVEL-END FLOAT

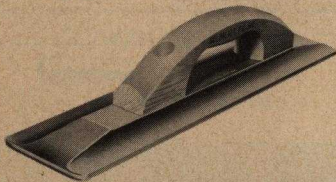

- BEVEL-END MAGNESIUM FLOAT**—The float with a backbone. The most popular, widely-used float manufactured. It has the strength of a forging. Very hard, long-wearing and extra-light, it is the toughest tool of its kind. The blade is broken-in with rounded corners.
 - 16" x 3 1/2" (Weight: 24 oz.)
06 150 M7...\$5.00
 - 12" x 3 1/2" (Weight: 16 oz.)
06 403 M7...\$3.60

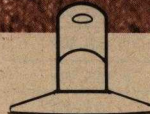

"THINLINE FLOAT"

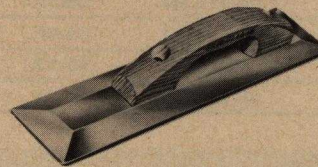

- THINLINE MAGNESIUM FLOAT**—With ends beveled down to 3/16" this float is thin enough to work in the tightest quarters. Has the famous Goldblatt broken-in blade and rounded corners. Handles like a dream, wears like iron, but gives "like wood" action.
 - 16" x 3 1/4" (Weight: 24 oz.)
06 164 M7...\$5.00
 - 20" x 3 1/4" (Weight: 26 oz.)
06 188 M7...\$6.55



MAHOGANY

- 45" MAHOGANY DARBY**—Specially designed three-grip handle makes this tool easy to use. Perfectly balanced: 3 5/8" at rear, tapers to 2 1/2" at point; 3/4" thick.
06 159 M7 \$6.25

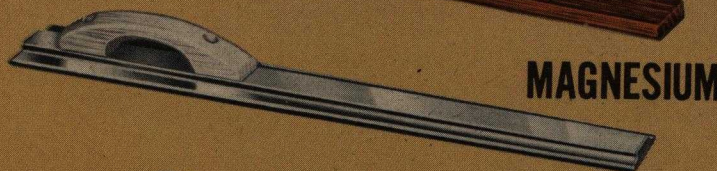

MAGNESIUM

- 30" TAPERED MAGNESIUM DARBY**—This is the darby the careful finisher uses. Lightweight, exceptionally easy to handle. The same, rugged, long-wearing extrusion as our famous Bevel-End Float. A perfectly balanced darby, 3 1/2" wide at heel, tapered to 2 1/4" wide at toe. Fitted with our most comfortable straight grain wood float handle.
06 139 M7 \$11.95



MAHOGANY

- 28" MAHOGANY DARBY**—Made of best, straight grain, kiln dried, imported mahogany. Manufactured to rigid specs: 3 1/2" wide at rear, tapers to 2 3/4"; 5/16" thick.
06 158 M7...\$3.55

**TAPERED
DARBIES**

● **MOLDED SPONGE RUBBER FLOAT**—This most popular sponge float is made by no one else. The sponge rubber is molded very compactly, with a dense texture. The shaped, molded rubber float face is then permanently cemented to a specially shaped back plate.

The texture of this float is as even and fine as any you will ever get anywhere. The float is fitted with our finest natural wood handle; the most comfortable to use handle yet devised.

Float size is 8" x 4".
03 295 M7.....\$2.20

Molded Float Pad—Fits this tool only. 8" x 4". 03 297 M7.....\$1.00

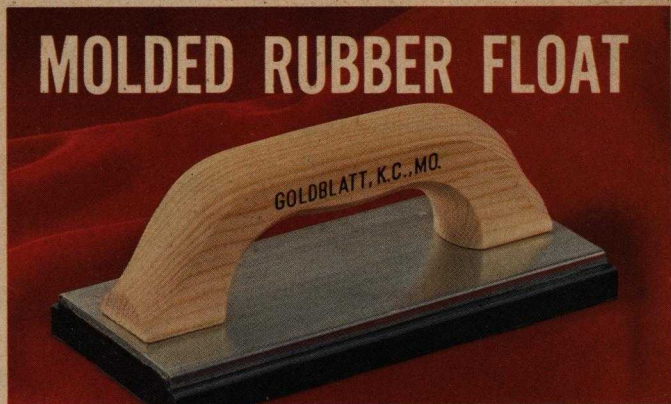

WIDE REDWOOD FLOAT

● **WIDE REDWOOD FLOATS**—Select redwood, fine handles, light weight. Favorite for years. You'll always have a use for one. Two popular sizes.

12" x 4 1/2".....06 151 M7...\$1.40
15" x 4 1/2".....06 152 M7...\$1.40

BEVEL-EDGE REDWOOD

● **BEVEL-EDGE REDWOOD FLOATS**—Favorites for close form work; light, easy to use, low cost. Made from select redwood, the float faces are beveled to prevent splintering and to make it possible to work in tight. Two sizes.

15" x 3 1/2".....06 156 M7...\$1.40
18" x 3 1/2".....06 157 M7...\$1.40

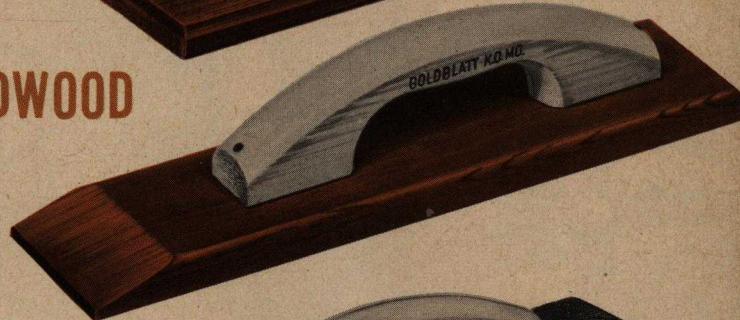

CORK FLOATS



● **WOOD-BACK CORK FLOAT**—The 3/4" Portuguese cork face is cemented with an insoluble glue to the specially treated knot-free wood back. A strong, light, warp-proof float particularly suitable for cement finishing. 11 1/2" x 4 7/8". Available Carton of 4.

06 153 M7.....\$3.60

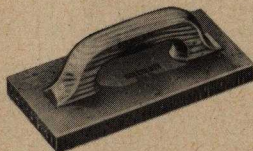

CORK FLOATS—Smooth, imported, virgin cork 12" x 5" x 1".
Handled06 154 M7...\$3.25
Without Handle.....06 155 M7... 2.20

"The Goldblatt tools—trowels and floats are the best quality ones I can buy."

G. F. Thurman
Dearman Street
Smithville, Tennessee

● **LAMINATED CANVAS-RESIN FLOAT**—Wears like steel, works the slab like wood. This high-pressure laminated canvas resin float is extremely dense to give you unbelievably long wear. Has broken in face, rounded corners; pick one up and go to work.

All floats 3 1/2" wide, 3/8" thick.
16" Float06 405 M7...\$6.15
18" Float06 406 M7...\$6.75
20" Float06 407 M7...\$7.50

● **TEAK FLOAT**—Gives you a finer finish, longer wear than most other woods. With our 10" knucklesaver float handle, this 18" x 3 1/4" float is "the best in the West."

06 169 H7...\$2.55

● **BODARK WOOD FLOAT**—This scare wood grows only in one corner of Oklahoma, so Bodark floats are hard to come by. But they outlast up to five ordinary floats, don't "fuzz up," and give you the right "drag" on the slab. Use yours right down to your knuckles, because the handle is bonded to the blade. 3 1/4" x 16" Bodark Float.

06 543 H7...\$2.85

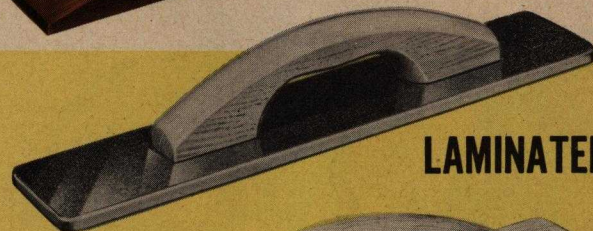

LAMINATED

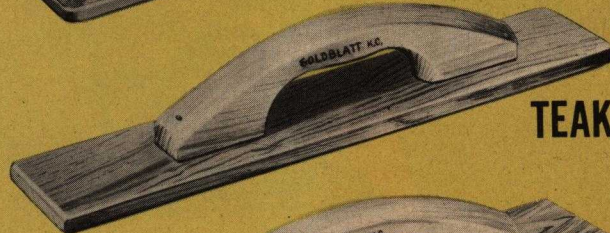

TEAK

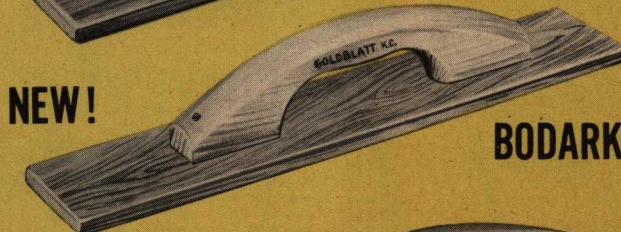

NEW!

BODARK



● **7 1/4" FLOAT HANDLE**—Favorite of plasterers and cement finishers. One only06 163 M7...\$.55



● **9 1/4" FLOAT HANDLE**—For all types of floats. One only06 162 M7...\$.55



● **10" FLOAT HANDLE**—Particularly popular among cement finishers. One only06 161 M7...\$.55

● **DRILLED, COUNTERSUNK HANDLE**—Same as above, but drilled and countersunk for easy attachment06 544 M7...\$.65

EDGERS

GOLDBLATT EDGERS—All of these stainless steel edgers are rivet-free, with perfectly smooth faces that will not scar concrete surfaces. Easy to use and clean, our stainless steel tools are long-wearing stainless. All have turned up edges for easy use along a straight edge. Turned up fronts prevent digging in. The heavy duty bronze edgers are cast in one piece then the faces are micro-polished for the smoothest edging possible.

**THICKER STAINLESS STEEL
FOR LONGER WEAR**

CURVED-END

● **CURVED END OUTSIDE EDGER**—Beyond a doubt, this is the most widely used edger in America. And the turned up ends are the reason. Cement finishers from coast to coast have proved to themselves that this tool is easier to work with than any other. Made of stainless steel, it is long wearing, non-rusting.

6" long, 3" wide, 1/4" radius.
06 241 M7...\$1.70
6" long, 2 1/2" wide, 1/4" radius.
06 242 M7...\$1.70

● 6" LONG SIDEWALK EDGERS			
Width	Radius		Price
1 1/2"	1/4"	06 261 M7	\$1.70
2 1/2"	1/4"	06 262 M7	\$1.70
3"	1/4"	06 263 M7	\$1.70
3 1/2"	3/8"	06 264 M7	\$1.70
4"	1/2"	06 265 M7	\$1.70
6"	3/8"	16 238 M7	\$2.05

The 6" edgers below have a 1 1/2" lip.

Width	Radius		Price
4"	1/2"	06 246 M7	\$1.95
4"	3/4"	06 247 M7	\$1.95
4"	1"	06 248 M7	\$1.95

● 8" LONG SIDEWALK EDGER			
4 1/2"	1/2"	06 266 M7	\$2.00
● 9" LONG HIGHWAY EDGER			
2 1/2"	1/2"	06 255 M7	\$2.00
● 10" LONG HIGHWAY EDGERS			
3 1/2"	1/4"	06 258 M7	\$2.00
4"	3/8"	06 259 M7	\$2.00
4"	1"	06 254 M7	\$2.00
● 10" EDGER WITH LIP—10" Long, 4" Wide, 1 1/2" Radius, 1 1/2" Lip			
			06 240 M7...\$2.95

CURB & SIDEWALK

● **MATCHED CURB & SIDEWALK EDGERS.** These tools are 6" long, 4" wide. Stainless Steel. Radius as shown, 1 1/2" lip on all tools.

[Outside Tool (1/2" radius).....			
			06 246 M7...\$1.95
[Inside Tool (1/2" radius).....			
			06 251 M7...\$1.95
[Outside Tool (3/4" radius).....			
			06 247 M7...\$1.95
[Inside Tool (3/4" radius).....			
			06 252 M7...\$1.95
[Outside Tool (1" radius).....			
			06 248 M7...\$1.95
[Inside Tool (1" radius).....			
			06 253 M7...\$1.95

STEP TOOLS

● **STEP TOOLS** — Matched inside and outside step tools for stairs requiring a batter. Both tools 8" long, 4" wide; have 4" lip, 1/2" radius; give a 1/2" batter.

Inside tool.....	06 277 M7...	\$3.60
Outside tool.....	06 278 M7...	\$3.60
Matched pair.....	06 279 M7...	\$6.90

CURB & GUTTER

● **CURB TOOL**—6" long, 5" wide at top, 3 1/2" side wall. Batter to center of radius is 1".

Radius 2".....	06 293 M7...	\$4.35
Radius 3".....	06 295 M7...	\$4.35

● **GUTTER TOOL**—6" long, side wall 4 1/2" wide, bottom wall 6" wide, 1 1/2" batter.

Radius 2".....	06 296 M7...	\$4.35
Radius 3".....	06 294 M7...	\$4.35

BASE TOOLS

● **STANDARD BASE TOOLS**—These are all 6" long, 6" wide with a 6" lip. Radius as shown.

(1/2" radius).....	06 281 M7...	\$3.85
(3/4" radius).....	06 282 M7...	\$3.85
(1" radius).....	06 283 M7...	\$3.85

STEP & CORNER

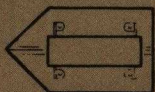
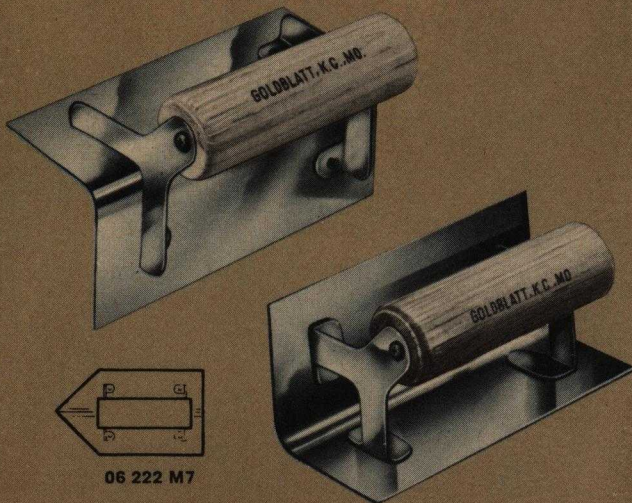

06 222 M7

● **STEP AND CORNER TOOLS**—All these tools 6" long, with 2½" sides. Radius as shown. 06 222 M7 cut back as shown in illus.

- Outside tool (no radius).....06 221 M7...\$1.80
- Inside tool (no radius).....06 222 M7...\$1.80

- Outside tool (½" radius).....06 223 M7...\$1.80
- Inside tool (½" radius).....06 224 M7...\$1.80
- Outside tool (¼" radius).....06 225 M7...\$1.80
- Inside tool (¼" radius).....06 226 M7...\$1.80

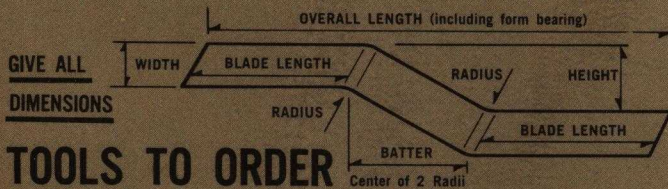

TOOLS TO ORDER

TOOLS TO SPECIFICATIONS! Send us an engineering drawing of the tool you need. We do the rest. Be sure to give us all dimensions and specifications as shown in the

drawing. We quote a firm price when we receive your drawing and quantity requirements. Allow at least two weeks for manufacturer.

HEAVY DUTY BRONZE



● **BRONZE EDGER** — The same popular "turned up ends" design that has made our stainless steel edger the most popular in America. A cinch to use. The turned up ends make it work smooth as

silk. Will give long, rugged service. Body is 6" long, 2¾" wide. The lip is ⅝" deep, on a ¼" radius. Weight, 18 ozs.

06 311 M7 \$3.75

WALKING EDGERS

ALL ANGLE



● **ALL ANGLE STAINLESS STEEL EDGERS**—Made of heavy-gauge, stainless steel, with All Angle Attachment so you can work at an angle to the slab edge. Welded reinforcing plate holds Attachment to blade, giving a perfectly smooth face, with no rivets. Turned up blade ends prevent gouging slab. With 6' Wood Handle. 10" x 3" blade; ¼" lip on ⅜" radius.

16 271 M7...\$9.50

10" x 6" blade; ½" lip on ⅜" radius With Handle.

16 270 M7...\$9.95

COMES WITH 6' WOOD HANDLE

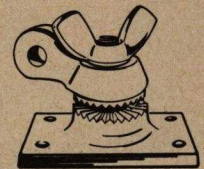
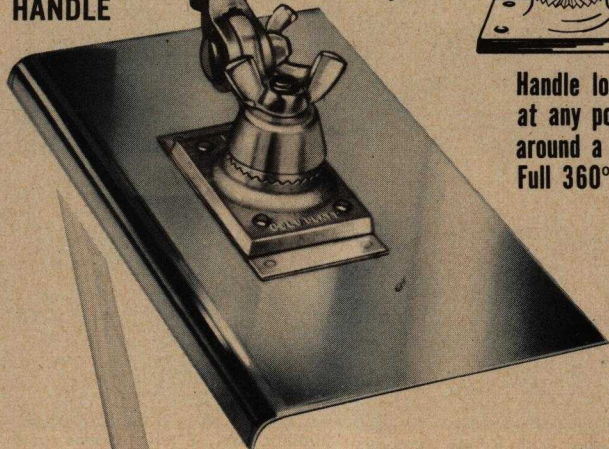

Handle locks at any point around a circle. Full 360° swing.

COMES WITH 6' WOOD HANDLE

FLIP-FLOP

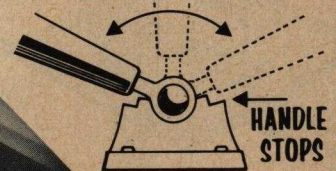
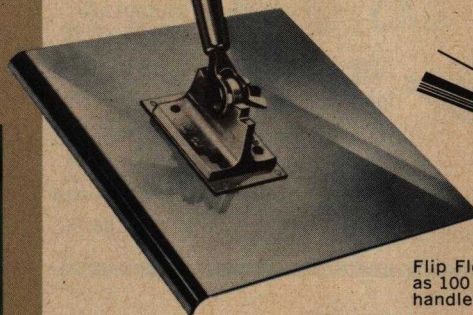

HANDLE STOPS

Flip Flop Handles cut out as many as 100 bend-downs a day to change handle setting.

● **STAINLESS STEEL FLIP-FLOP WALKING EDGERS**—Practically eliminate bending down. Tighten the handle of this "walking" edger finger tight and you can flip it from one side to the other without bending down to adjust it—or you tighten all the way and the tool becomes a conventional single action long-handled edger. Positive handle stops prevent the handle from "flipping" too far. Designed for comfortable, easy use when using the flip-flop feature. Made of heavy-gauge, stainless steel, in four different sizes, the tool is reinforced with an elec-

trically welded backing plate to which the handle attachment is fastened. No rivets or rivet heads break up the completely smooth face of this tool. Edge can be dressed and re-rolled often to extend tool life many times.

Comes with 6' Wood Handle.

- 10" x 6" Edger with ⅜" Radius 16 231 M7...\$9.95
- 10" x 6" Edger with ½" Radius 16 232 M7...\$9.95
- 10" x 10" Edger with ½" Radius 16 233 M7...\$11.50
- 8" x 4" Edger with ½" Radius 16 234 M7...\$9.50

GROOVERS

STAINLESS STEEL, BRONZE
and MALLEABLE

On this page you can find groovers for every concrete finishing job. Make your choice of stainless steel, bronze or perlitic malleable iron—these are the long-wearing groovers that set the standard for cement finishers. Ask the man on the knee board who makes the clean cutting groover he's using. The chances are five to one that he'll say "Goldblatt". That's because we make our groovers the way the professional finishers need them. Our stainless steel is heavy gauge, long wearing, easy to clean. No rivets mar the surface of these tools. The natural wood handles are comfortable to use. And they last! Our Bronze is in a class by itself. Bronze tools cost a little more than cast iron—but they're worth it. They have the heft and weight that make it easy to cut sharp, clean grooves. And there are no other tools that can compare to our Perlitic Malleable Iron and Ultra Hard groovers. Specially hardened, they outlast competitive groovers every time. That's the way we make them. And that's why we make (and sell) more sizes, styles and types of groovers than any other company. We set the standard other manufacturers shoot for.



TURNED UP
IN FRONT

TURNED UP IN FRONT

UNIVERSAL

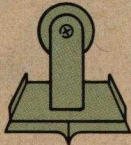

6" long
3" wide

● **UNIVERSAL GROOVER** . . . has 6"x3" blade. Cuts 1/2"x1/2" groove "clean as a whistle." And cleans just as easy.....06 208 M7....\$2.25

JUMBO

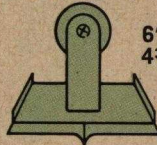

6" long
4 3/4" wide

● **JUMBO GROOVER** . . . a very popular tool. 6"x4 3/4" blade cuts 3/8"x1/2" groove. A reliable tool. 06 209 M7....\$3.90

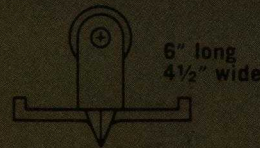

6" long
4 1/2" wide

● **BIG BIT BRONZE GROOVER**—Has the widest bit of any groover we make, but not quite as deep as Deep Bit Groover. Bit size is 7/8" wide at top, 3/4" deep . . . Weight, 2 lbs., 4 ozs.

06 304 M7 \$5.95

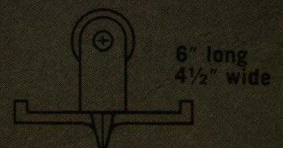

6" long
4 1/2" wide

● **DEEP BIT BRONZE GROOVER**—The deepest groover we make, though not quite so wide at the top as the Big Bit Groover. Bit size is 1/2" wide at top, 1" deep. Weight, 2 lbs., 6 ozs.

06 314 M7 \$7.30

DEEP BIT GROOVER

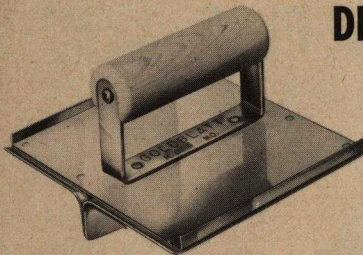

● **DEEP & THIN GROOVERS**—Thin, deep groove prevents spike heels from catching in pavement. These three groovers have 6"x6" body, with thin, 1/8" wide bits on 1/4" radius to make grooves to state and municipal specs.
2" Groover.....06 217 M7....\$5.60
1 1/2" Bit Groover.....06 216 M7....\$4.90
1" Bit Groover.....06 215 M7....\$4.25
● **PAVER'S GROOVER**—Body of this tool is 10"x3 1/2"; bit 1 3/8" deep on 1/4" radius, 1/8" wide
06 207 M7....\$5.75

CHEATER

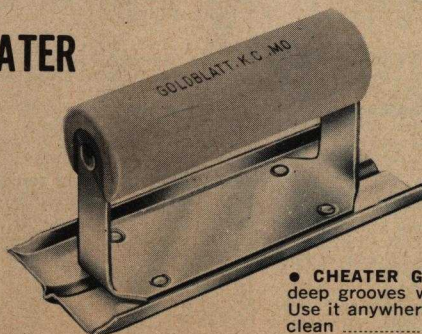

● **CHEATER GROOVER**—Make 1/8" deep grooves with this 6"x2" tool. Use it anywhere. Works fast, marks clean06 206 M7....\$2.25

● **DENVER GROOVER**—Turned up front preferred by Western finishers. Body is 6 1/2" long, 3" wide. Bit is 3/4" deep and about 1/4" across at its widest point. Weight 23 ozs. 06 300 M7....\$5.20



● **SAFETY STEP EDGER**—Edge stairs and make four safety grooves at the same time. 1/2" deep lip with 1/2" radius makes standard edge. Tool is 5 1/2" long and 4 3/4" wide. Stainless Steel....06 212 M7....\$4.25

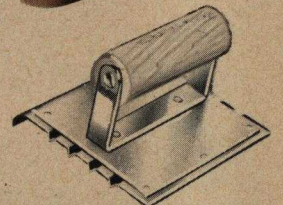

COMBINATION EDGER-GROOVER

● **COMBINATION EDGER / GROOVER**—Cut costs and working time when curb and sidewalk are poured together. This heavy gauge edger forms the top edge of the curb—and cuts groove about 1/4" deep, 3/8" wide at top in one pass along the slab. Center of groove is 5/8" from center of 3/4" radius edging lip. The blade is 8 1/4" wide, 6" long overall. Electrically welded throughout. No rivets to loosen or scar your slabs. Our special Stainless Steel is 25% thicker than most other tools for much longer wear, cleaner work.

16 249 M7....\$7.75

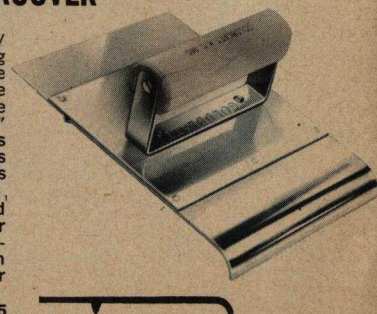

ORDER BLANK: In Center Fold

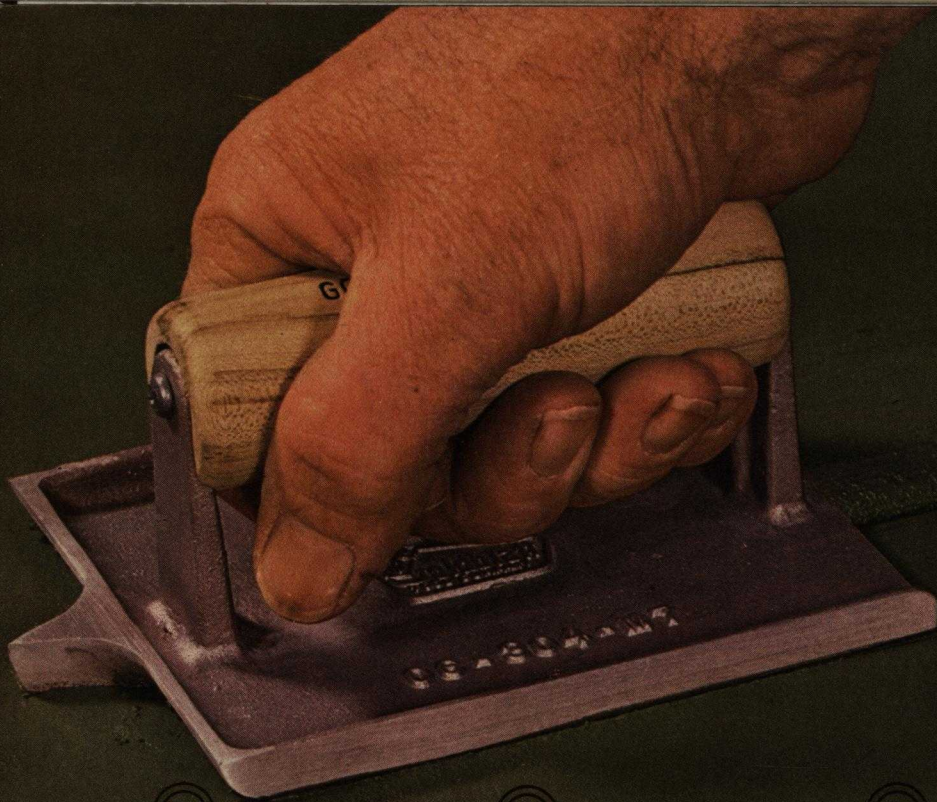

● **LARGE MALLEABLE IRON GROOVER**—Similar to other groovers, but cast of fine perlite malleable iron. Polished to an ultra-smooth working finish. Bit size is 5/8" wide at the top, 3/8" deep. Weight, 2 lbs. 06 296 M7 \$ 3.95

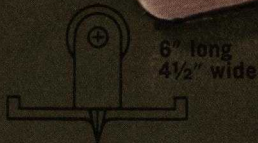

● **NARROW BIT BRONZE GROOVER**—Some municipal sidewalk specifications call for this narrow, but fairly deep groover. Bit size is 3/8" wide at top, 3/4" deep. Weight 1 lb., 12 ozs. 06 305 M7 \$5.50

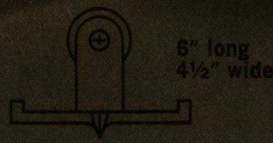

● **LARGE BIT BRONZE GROOVER**—Body is 6" x 4 1/2"; bit is 3/8" wide at top, 1/2" deep. Weight 1 1/2 lbs. 06 303 M7...\$4.80

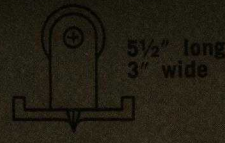

● **MEDIUM BIT BRONZE GROOVER**—Body is 5 1/2" long, 3" wide; bit is 5/16" wide at top, 3/8" deep. Weight 17 oz. 06 302 M7...\$3.75

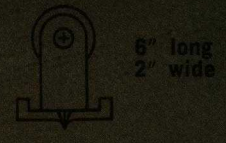

● **SMALL BIT BRONZE GROOVER**—Body is 6" long; 2" wide; bit is 3/16" wide at top, 3/16" deep. 06 301 M7...\$3.75

WESTERN



● **WESTERN GROOVER**— Easy to use, semi-rocker style groover. Cuts 3/16" deep. This tool is 2"x3" with "easy grip" handle. 06 201 M7...\$2.30

● **ULTRA-HARD GROOVER**— So hard and so long-wearing you won't believe it. Cast in a special chrome-nickel-iron alloy exclusively for us, this tool is harder than a file. Try to file it if you don't believe it—and if you don't mind ruining your file. We tell you this to give you some idea of how this new tool will wear, and wear, and wear and wear.

Tighten the wing nut to work at any angle you choose. Body of tool is 4" wide, 3 1/2" long, makes a groove 1/4" wide, 3/8" deep. with 6" Handle 06 204 M7...\$6.95

● **ULTRA-HARD BIT ADJUSTABLE GROOVER**— Here's a new version of our adjustable bit groover with a bit that's as hard as a file. The 1/16" thick tempered spring steel bit in this tool has been specially hardened to wear longer than any similar product we know of. The blade adjusts to make grooves from 1/16" to 1/2" deep. Body of the hardwood handled tool is 2 3/4" square 06 316 M7...\$4.50
Ultra-Hard Bit Only 06 203 M7...\$.75

WALKING GROOVERS

Handle locks at any point around a circle.

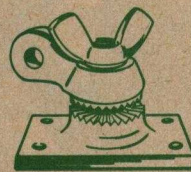

Your choice of two groove sizes: 1/2" deep on 3/8" radius or 1" deep on 1/4" radius.

● **STAINLESS STEEL WALKING GROOVERS**— Heavy gauge reinforced stainless steel fitted with an All Angle Attachment. Blade edges are turned up on all sides to work along forms and to prevent gouging. A reinforcing plate welded to the back of the blade holds the All Angle Attachment, leaving the face smooth, with no rivet heads. Comes with 6' Wood Handle.

10" x 3 1/2" blade; 1/2" deep bit on 3/8" radius...16 273 M7...\$10.50
8" x 6" blade; 1" deep bit on 1/4" radius With Handle 16 247 M7...\$11.00

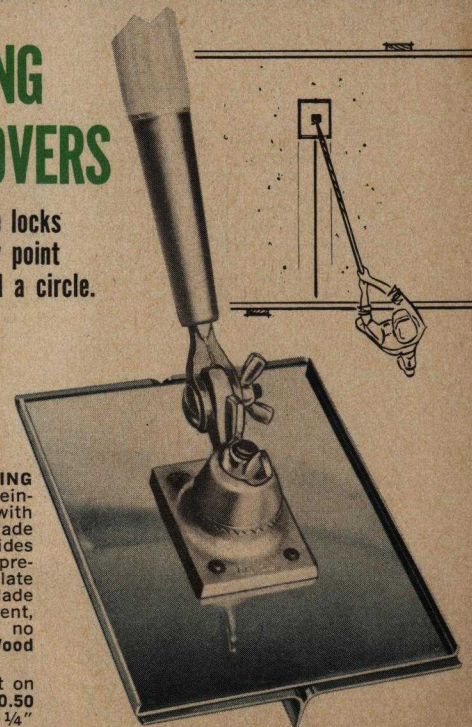

Magnesium BULL FLOAT

with handle bracket

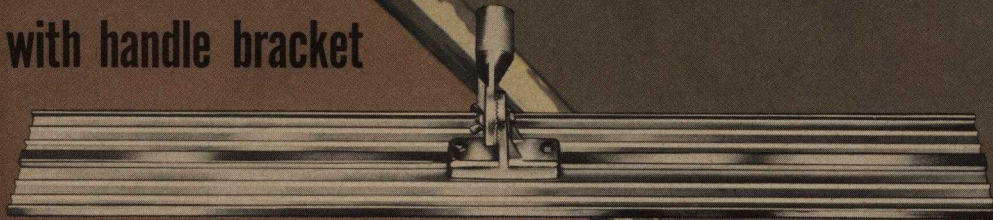

• **GOLDBLATT MAGNESIUM BULL FLOATS**—Made of dense, compact grain extruded magnesium. We've worked ten years to bring you these lightweight, long wearing floats. Because they're magnesium they work the slab smoothly—concrete won't "cling" to mag the way it will to other materials. This means easier floating for you. These floats take much of the load off your back and arms—a few pounds in float weight makes a huge difference at the end of 12' or 16' of handle.

WITH THE FLOATS LISTED AT RIGHT USE ONLY LIGHTWEIGHT LONG HANDLES WITH MOLDED THREADS: 16 324 M7, 16 326 M7, 16 670 M7 or 16 668 M7.

42" x 8" FLOAT

Magnesium Float only with bracket, 16 305 M7....\$31.00

48" x 8" FLOAT

Magnesium Float only with bracket, 16 306 M7....\$34.00

54" x 8" FLOAT

Magnesium Float only with bracket, 16 101 M7....\$37.00

60" x 8" FLOAT

Magnesium Float only with bracket, 16 102 M7....\$40.00

ORDER HANDLES
FOR THESE FLOATS
ON FACING
PAGE

HEAVY DUTY,
TOOTHED
BULL FLOAT BRACKET

With extra-large, tight-locking teeth, this is the most rugged float bracket made. Heavily reinforced at the handle socket—the weak point in most float brackets. A twist of the thumbscrew locks the handle in the position you select—and it stays there.
Jitterbug Float Bracket
16 676 M7....\$7.00

Poplar or Wood Float Bracket (Fits Goldblatt or your own home-made float).....16 677 M7....\$7.00

Handle Socket Only (fits either of above)16 678 M7....\$3.50
Bracket Base Only for wood float
16 680 M7....\$3.50
Bracket Base Only for metal float
16 681 M7....\$3.50

LAMINATED POPLAR FLOAT

• **LAMINATED POPLAR FLOAT**—Made of many strips of sturdy poplar laminated together with the grain "on edge". Poplar is best for floating, because it has just the right porosity and strength to do a fine job of finishing concrete. It is long-wearing, doesn't splinter. Will finish thousands of yards of concrete with no signs of wear. Ends are thinned down to help you get under steps and other low clearance areas. Both the 48" and 60" floats are 1 3/4" thick in the middle, taper to 3/8" at the ends.

This float gives you all the advantages of using our new handles with large molded threads plus the action of wood on the slab—and a big bonus: Outlasts home-made wood floats many times.

WITH THE FLOATS LISTED BELOW USE ONLY LIGHTWEIGHT LONG HANDLES WITH MOLDED THREADS: 16 324 M7, 16 326 M7, 16 670 M7 or 16 668 M7.

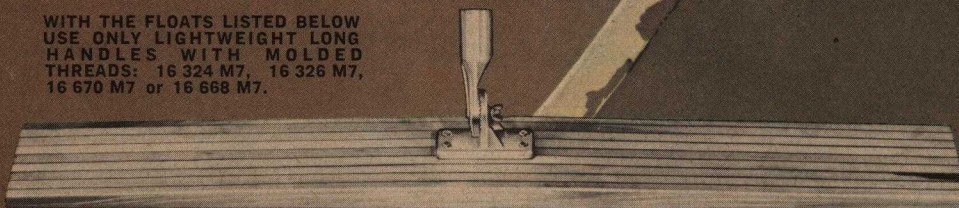
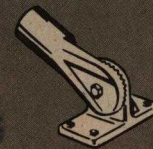
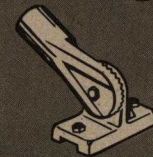

48" x 7 1/4" FLOAT

Float Only with Bracket 16 782 M7....\$20.95

60" x 7 1/4" FLOAT

Float Only with Bracket 16 780 M7....\$22.95

with handle bracket

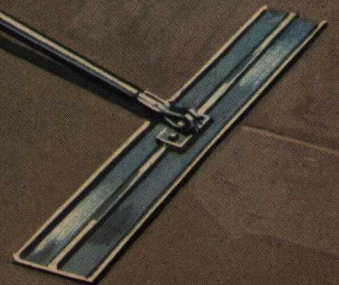

Aluminum JITTERBUG FLOAT

with
handle bracket

• **GOLDBLATT IMPROVED SMOOTH BOTTOM ALUMINUM JITTERBUG FLOAT**—Here is an entirely new extrusion, but in exactly the same shape as the familiar Goldblatt Jitterbug Float that you've used for years. A reinforced cross section plus huskier backbone prevents warping but adds so little weight you can't notice the difference. Makes a truly great float greater. This Bull Float is the standard of the industry from coast to coast. Still 8" across, it is now available in

widths up to 60". Has Goldblatt's carefully broken in shape so you can use it the day you buy it with no tedious, time-consuming break-in period. The new heavy-duty handle bracket furnished with the tool locks the handle in the most comfortable position for you to use.

WITH THE FLOATS LISTED AT RIGHT USE ONLY LIGHTWEIGHT LONG HANDLES WITH MOLDED THREADS: 16 324 M7, 16 326 M7, 16 670 M7 or 16 668 M7.

42" x 8" FLOAT
Float Only with Bracket.
16 770 M7....\$26.10

48" x 8" FLOAT
Float Only with Bracket.
16 772 M7....\$29.10

60" x 8" FLOAT
Float Only with Bracket.
16 774 M7....\$31.10

GOLDBLATT'S LONG HANDLES -WITH RUGGED MOLDED THREADS

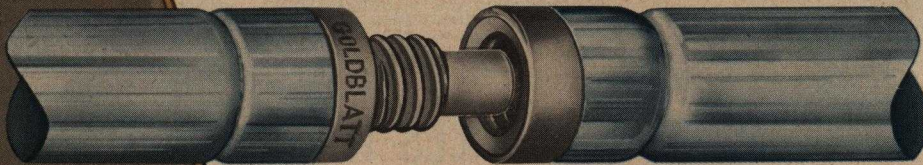

• **1 3/4" DIA. GOLDBLATT HANDLES**
This rigid, hand-fitting handle fits both the improved bull floats on these two pages and the floats shown on Page 17. They also combine with the 1 1/4" handles with molded threads as well as similar handles made by others. Strong,

easy to join together, easy to use and long lasting. Weigh no more than 1 1/4" handles, yet many prefer the greater rigidity and big "feel" of these 1 3/4" handles.

6' Handle.....16 326 M7....\$9.00
4' Handle.....16 324 M7....\$6.00

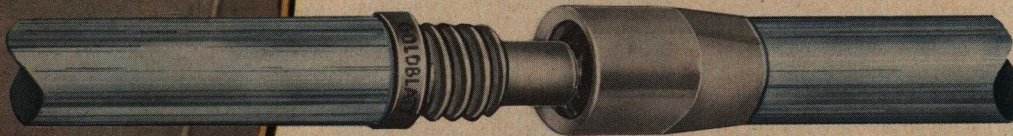

• **1 1/4" DIA. EXTENSION HANDLES**
The same diameter as your old-style Goldblatt handles, but with new molded round threads that are easy to clean, easy to join, need no couplings. Will stand up under rough use in the field when other types fail. Don't confuse these highly superior handles with low cost handles of inferior materials or coupling

methods. These 1 1/4" handles attach to the 1 3/4" handles with molded threads shown above and to all similar handles made by others.

Made of rugged, long-lasting, light-weight aircraft alloy for longest possible life.

6' Handle.....16 670 M7....\$8.25
4' Handle.....16 668 M7....\$6.90

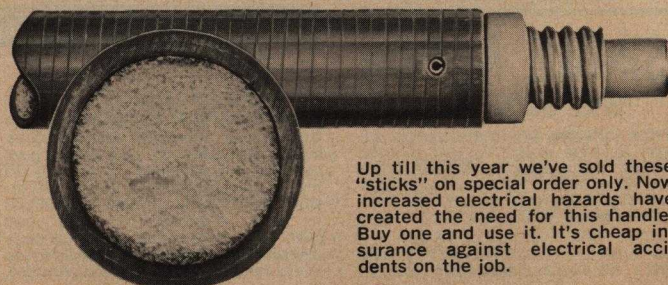

Up till this year we've sold these "sticks" on special order only. Now increased electrical hazards have created the need for this handle. Buy one and use it. It's cheap insurance against electrical accidents on the job.

**THREADS WON'T WEAR OUT
CAN'T CROSS-THREAD
ELIMINATES COUPLINGS!**

ABOUT THESE NEW HANDLES
— The large round molded threads on these new handles are easy to clean, easier to join and separate in the field than any others you work with. They will not load up with mortar, cross-thread or get banged up easily. Made to take it, they Both 1 1/4" and 1 3/4" handles are extremely lightweight, but immensely strong aircraft alloy. Both sizes fit each other as well as similar handles made by others. You'll get more use out of these improved handles than any others you've owned.

These handles can be made to fit 16 294 M7, 16 296 M7 or Goldblatt long handles bought before 1965 by using the Handle Adaptor (16 310 M7) shown on page 12.

• **INSULATING EXTENSION HANDLE**—This fiberglass handle will not conduct electricity because it's made of the same material as the lineman's "hot stick". The 6' long, 1 1/2" o.d. spiral-formed epoxy and fiberglass handle is foam filled and capped to prevent moisture from getting into the handle. Complete with male and female connectors. This is the strongest 6' extension handle ever made—many times stronger than your metal handles. Crush-proof practically indestructible.....16 672 M7....\$16.95

FRESNO TROWELS

● GOLDBLATT FRESNO TROWELS

—With the handles and attachments shown on this page, you can match your Goldblatt Fresno to any job condition. Order the All Angle Trowel at right to work at an angle to the slab. Order a Posi-Lok bracket to lock your metal handles at the most convenient, comfortable height for fast, easy finishing. Order carefully to make sure you get the right combination of handles and Fresno attachments for the jobs you do. One low cost attachment often saves lots of long, hard work.

ALL ANGLE HEAD

● With large, plated wing nut and deep, positive locking teeth, this is the huskiest steel Fresno handle attachment made. Once you lock it, it stays locked. A precision fitting that works right all the time.

Handle attachment replacement part (top only). 16 288 M7....\$.90

Handle locks at any point around a circle.

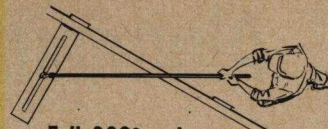

Full 360° swing.

BROKEN-IN

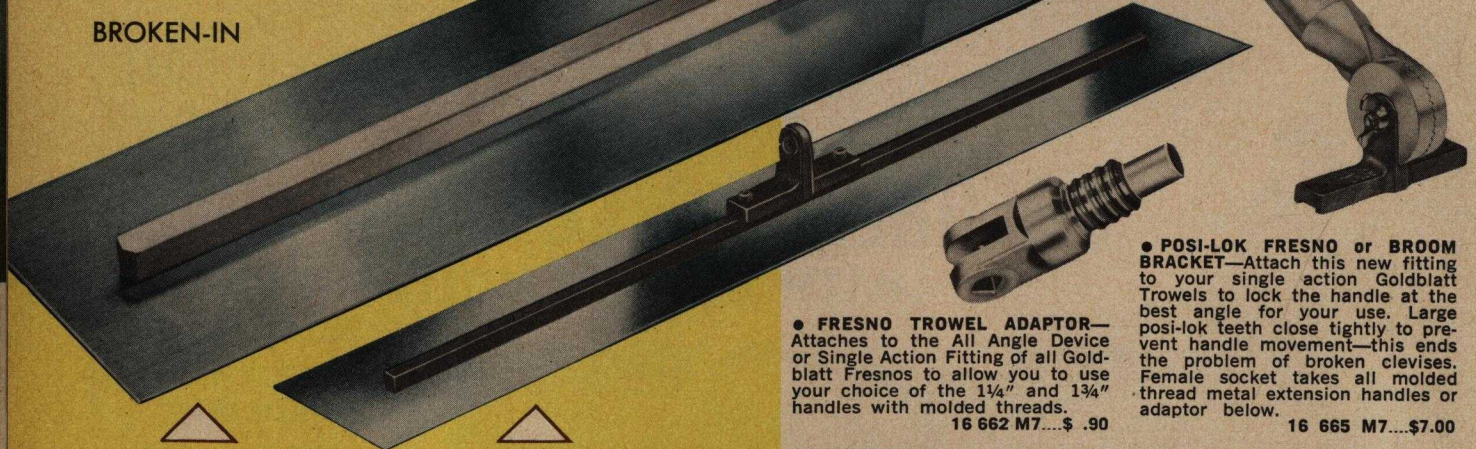

ALL ANGLE

SINGLE ACTION

HEAT TREATED ALUMINUM or STEEL SHANK

● **ALL ANGLE FRESNO TROWELS**—Work hard-to-get-at places with ease. Set the All Angle fitting to walk alongside a sidewalk, troweling as you go or set it for back and forth fanning action. You'll get more use from this trowel than from any other Fresno you've owned! Reach in, under or around forms and other obstruction by setting the handle to the best position for the job. The handle attachment is cast steel. Wrought aluminum or steel rib. Broken in.

● **SINGLE ACTION FRESNO TROWELS**—This is the same high carbon tempered steel blade as the All Angle Fresno Trowels described at left, but with a simple cast steel post with a low center of gravity. Many finishers prefer the troweling action they get by attaching the handle to this fitting. Definitely the trowel to buy if you don't need the extra convenience of the All-Angle Head. Your choice of wrought aluminum or steel rib. Broken in.

ALL ANGLE
With Aluminum Shank

Price includes blade and All Angle attachments only. To use molded thread handles with Fresno Trowels listed below you must use handle attachment 16 662 M7 or Posi-Lok Bracket 16 665 M7.

24 x 5".....16 642 M7....\$ 9.50
30 x 5".....16 644 M7....\$10.25
36 x 5".....16 646 M7....\$13.50

SINGLE ACTION
With Aluminum Shank

Price includes blade and single action bracket only. To use molded thread handles with Fresno Trowels listed below you must use handle attachment 16 662 M7 or Posi-Lok Bracket 16 665 M7.

30 x 5".....16 635 M7....\$10.00
36 x 5".....16 638 M7....\$13.20

ALL ANGLE
With Steel Shank

Price includes blade and All Angle attachments only. To use molded thread handles with Fresno Trowels listed below you must use handle attachment 16 662 M7 or Posi-Lok Bracket 16 665 M7.

24 x 5".....16 906 M7....\$ 9.50
30 x 5".....16 907 M7....\$10.25
36 x 5".....16 908 M7....\$13.20

SINGLE ACTION
With Steel Shank

Price includes blade and single action bracket only. To use molded thread handles with Fresno Trowels listed below you must use handle attachment 16 662 M7 or Posi-Lok Bracket 16 665 M7.

30 x 5".....16 903 M7....\$10.00
36 x 5".....16 904 M7....\$13.20

HANDLES for Fresno Trowels



● **1/4" EXTENSION HANDLES**—The same diameter as your old-style Goldblatt handles, but with new molded round threads that are easy to clean, easy to join, need no couplings. Will stand up under rough use in the field when other types fail. Don't confuse these highly superior handles with low cost handles of inferior materials or coupling methods.

These 1/4" handles attach to the 1 3/4" handles with molded threads and to all similar handles. Made of rugged, long-lasting, light-weight aircraft alloy

6' Handle.....16 670 M7....\$8.25
4' Handle.....16 668 M7....\$6.90



● **HANDLE ADAPTOR**—Fits molded and machine threaded handles together. Adaptor is 6 1/2" long, 1 1/4" in diameter with machined male threads at one end, molded male threads at other. Fits all popular handles, but is not intended for use with 1 3/4" diameter handles.

16 310 M7....\$2.95

WOOD HANDLES



● **WOOD HANDLES**—Clear, knot-free, straight grain hard wood with a heavy duty steel ferrule and clevis. Attaches to any Goldblatt long-handled trowel, edger or groover.

6' Handle16 283 M7.... 3.75



● **LIGHTWEIGHT EXTENSION HANDLES**—Use only with long handles with machine-cut threads purchased before 1965. Combine to make any length. To be used on Bull Floats and Fresnoes, bought in 1964 or earlier. Must be used with 60" magnesium darby, (page 13) and the Rollerbug (Page 16) as they take only this style handle.

Quick, fast, light and efficient, each handle length comes complete with one coupling.

6' Handle.....16 296 M7....\$7.00
4' Handle.....16 294 M7....\$5.00

● **MAGNESIUM COUPLING**—Internal threads on this coupling attach Goldblatt Magnesium Handles together to make any length handle.....16 291 M7....\$.90

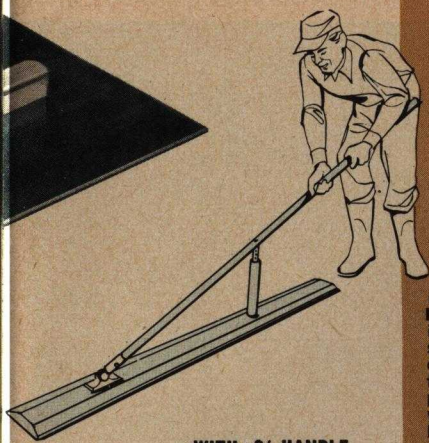

WITH 6' HANDLE

MAGNESIUM DARBY

● **60" LONG HANDLED MAGNESIUM DARBY**—Here is the tool you need to darby large areas in a hurry. Made of our standard "Thin-line" hard magnesium alloy extrusion, this "really big" darby is a cinch to handle. Just what the doctor ordered for medium sized slabs and jobs where you want to darby a big area in a hurry. Very lightweight. A simple pin adjustment changes the height and angle of the handle for utmost comfort and usefulness. Handle is 6' long. Gives you a forward reach of 8' or more. For longer reaches, attach our magnesium extension handles (Page 11). A rugged tool that takes hard knocks and gives A-1 service. **BROKEN IN Weighs under 7 lbs.**
06 146 M7...\$33.50

CHISELS



TWO SIZES

● **CONCRETE CHISEL**—Fine forged steel for chipping concrete. $\frac{5}{8}$ " shank.
10" long, 2" bit...16 554 H7...\$2.60
12" long, 3" bit...16 555 H7... 3.80

HANDLE ATTACHMENTS FOR GOLDBLATT FLOATS & FRESNOES BOUGHT BEFORE 1965—

Fit only old - style, machine threaded handles shown at left.



● **HANDLE ATTACHMENTS** — Attach old-style machine threaded handles 16 294 M7 or 16 296 M7 to long-handled cement tools. Be sure to order the proper attachment; the attachment for wood or metal bull floats is different from the attachment for Fresnoes, groovers and edgers. Attachment For Bull Floats 16 560 M7...\$2.50 Attachment for Trowels, Groovers and Edgers...16 308 M7...\$2.50



● **KNEEL-LITE NEOLITE KNEE PADS**—Tough Neolite plastic facing is long-lasting. Lined with felt shaped to fit your knee. Steel rivet construction holds pad in shape forever. One leather strap holds in place. These knee pads won't cut when you walk, won't slip down. Rugged but comfortable.
Per Pair.....06 173 H7...\$8.50



● **RUBBER CUSHION KNEE PADS**—Solid rubber surface for rugged long wear. The soft rubber on the inside cushions the knee socket. Adjustable web straps are completely embedded within the pad. These pads do not slip down when they are walked in. Prevent moisture from penetrating clothes, add life to work clothes. Increase efficiency; lessen fatigue.
Per Pair.....06 170 H7...\$2.70



● **LEATHER & FELT KNEE PADS**—Hard wearing, long lasting, but pliable and comfortable. Lined with soft felt, these knee pads are almost flat, but they're flexible and bend with the knee. One pliable leather strap holds each pad on—won't bind or let the pad slip while you walk. Per Pr...06 171 H7...\$5.05

KNEE PADS & RUB BRICKS



● **FLUTED SILICON CARBIDE RUB BRICKS WITH HANDLES**—The comfortable, well-contoured handles minimize fatigue. Preferred by most concrete workers. The fastest, most economical cutting medium known for dressing down all kinds of concrete work.

20 Grit Rub Bricks

6"x3"x1".....06 183 H7...\$3.35

8"x3½"x1½".....06 168 H7... 5.00

60 Grit Rub Brick

6"x3"x1".....06 182 H7...\$3.35

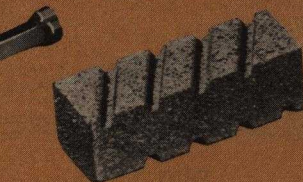

● **SILICON CARBIDE RUB BRICKS WITHOUT HANDLE** — Fluted two sides to give a shear cut. Removes form and mold marks. 20 grit.
6"x2"x2".....06 462 H7...\$2.05
8"x2"x2".....06 482 H7... 2.70



● **BROKEN-IN RUB BRICK**—properly shaped for fast cutting.
8" x 3½" x ¾", 20 Grit.
06 181 H7...\$4.20

HAIVALA FLOATS

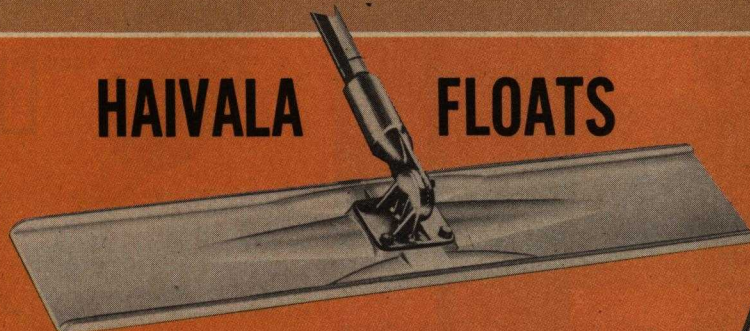

● **MAGNESIUM FLOATS WITH FLAT FACES & RAISED EDGES**—Without handle.
42"x8" Float...16 301 H2...\$33.00
47½"x8" Float...16 302 H2... 38.00
53½"x7" Float...16 303 H2... 40.00

● **MAGNESIUM FLOATS WITH HALF-CORRUGATED — HALF-FLAT FACES.** Corrugations on $\frac{3}{8}$ " centers

with about $\frac{1}{16}$ " penetration. Without handle.
38"x6½" Float...16 316 H2... \$35.00
Corrugations on $\frac{3}{8}$ " centers with about $\frac{1}{8}$ " penetration. Without handle.
40"x7½" Float...16 317 H2...\$42.00
● **EXTRA MAGNESIUM FLOAT BRACKETS**—For the Haivala Floats above only...16 321 H2...\$7.50

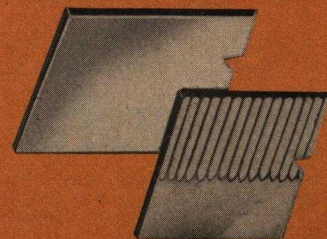

KUMALONGS MOVE CONCRETE

• **CONCRETE KUMALONG**—The perfect strike-off tool. One Kumalong is worth several shovels. Spreads, grades, smooths and floats. Fits inside a Georgia Buggy. Use a Kumalong to make final screeding a snap. The jam-type ferrule holds the 54" handle tightly. This patented 20" x 4" bladed tool is made of 14 gauge cold rolled steel. Kumalong with handle weighs 3½ lbs., ships Parcel Post. Pat. #3,213,476.

With Handle.....16 106 H7....\$5.45

• **KUMALONG WITH HOOK**—The same tool described above with a hook attached to the top edge of the blade. Flip the tool over and lift reinforcing wire without stopping. Hook can't catch wire accidentally. A great improvement on a useful tool. Pat. #3,264,668.

With Handle.....16 105 H7....\$5.70
Handle Only.....16 107 M7....\$.95

WITH OR WITHOUT HOOK

• **CONCRETE RAKE**—This sturdy, lightweight all steel rake lets you place concrete where you want it—use the tooth side for raking. The teeth are strong enough to lift mesh; use the smooth edge for screeding or floating.

4½" x 22" blade, 1¼" wide teeth, 1½" deep on 1½" centers. Handle, included in price, is 54" long. Weighs only 3 lbs., 10 oz.

Concrete Rake16 110 M7....\$4.40



Complete with 6' 16 670 M7 extension handle.

• **ROLLERBUG™** — Here is the roller that has proven best. Contractors who have used the Rollerbug™ are delighted with the surface it leaves for floating and finishing. It is ideal for all finishes: exposed aggregate, float, broom or trowel, or as a key for two course work. Excellent to depress exposed aggregate.

Once you've rolled the rollers over the slab and back, you've leveled and tamped an area 3' wide and as long as you can reach—in just about the time it takes you to read this sentence. Compare that to hand tamping, and figure out

the time you'll save.

No moving parts but the rollers. Nothing to get out of order. Maintenance is simple: Clean the rollers just as you do your other cement tools.

To be used only with 16 670 M7 and 16 668 M7 magnesium extension handles shown on Page 12.

Specifications: 39" wide overall; rollers, 36" wide, 5" diameter

Money Back Guarantee. Roller Bearings Guaranteed for 1 YEAR.

16 652 M7....\$51.00

ONE Rollerbug replacement roller. 16 654 M7....\$21.00

CONCRETE RAKE

STEEL STAKES

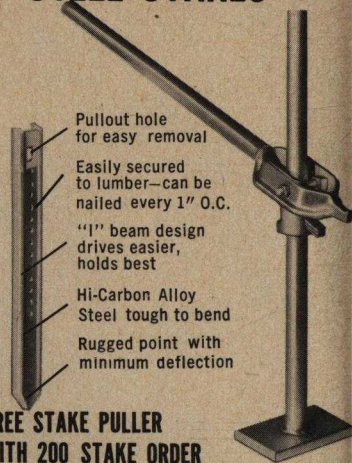

Pullout hole for easy removal

Easily secured to lumber—can be nailed every 1" O.C.

"I" beam design drives easier, holds best

Hi-Carbon Alloy Steel tough to bend

Rugged point with minimum deflection

FREE STAKE PULLER WITH 200 STAKE ORDER

• **EASY-OUT STAKE PULLER**—This rugged steel stake puller lifts stakes out of hard or frozen ground easily. Pulls stakes that are above ground from 3" to 36".

16 486 E2....\$10.50

• **SYMONS STEEL STAKES** — Use these rugged Steel I-Beam stakes over and over again!

These stakes are painted red on top, so workmen can see them. Because they are flat, they drive easily, fit snugly against forms. Made of high carbon alloy steel. Special pullout hole makes these stakes exceptionally easy to pull.

SOLD IN UNBROKEN PACKAGES ONLY—F.O.B. CHICAGO, ILL.

	No. in	Pkg.	Cat. No.	Cost
Length				
12"	25	16 480 E2	\$21.00
18"	25	16 481 E2	23.60
24"	25	16 482 E2	26.25
30"	25	16 483 E2	32.80

LUTES



• **ALUMINUM ASPHALT LUTES**—Unbelievably light, this aluminum lute and rake combination won't stick to asphalt and resists abrasion.

The "T" Beam head is serrated on one edge, flat on the other. Teeth are rounded to prevent catching material. A 36" lute with a 7' pole weighs under 3½ lbs. with Handle.

30" Lute 07 838 E7....\$15.25

36" Lute 07 839 E7....\$15.75

ROLLERBUG

ends wading in the mix

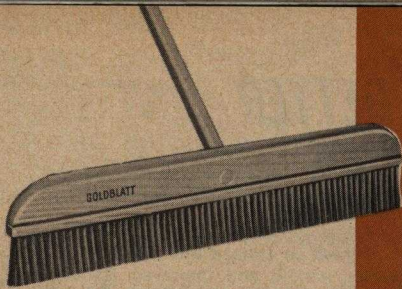

● **PLASTIC BRISTLE BROOM**—For fine-textured broom finish. Long-wearing, 2¼" bristles are solidly set into 7/8" thick wood holder. Two sizes, each complete with 60" handle.

18" Broom16 165 H7...\$6.75
24" Broom16 164 H7.... 7.75

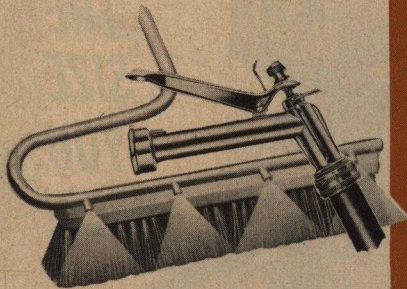

● **EXPOSED AGGREGATE BROOM** Simply by squeezing the broom handle, the finisher washes off the excess material and cleans the slab. Water sprays through four brass ports.

Interchangeable bassine medium and nylon heavy duty brushes are furnished. Both are 18" wide, about 3" long; a squeeze valve on the 48 handle adjusts water volume. Spray locks in "on" position.

07 216 H7...\$31.50



● **24" POSI-LOK BROOM**—Here's a fine, 24" bassine-bristled broom that fits the lightweight extension handles you already own. Not only eliminates the need for a separate broom handle, but actually improves your control over the broom. The first finisher who tried this new Posi-Lok Broom wouldn't give it back—that's how good it is. Buy the broom complete and use the handles you now own or order the Posi-Lok Bracket (Page 12) and attach it to any broom you like.

16 162 M7...\$12.95



JITTERBUG® TAMPERS

SLIGHTLY
BENT
HANDLES
FOR
PERFECT
BALANCE

GRILL IS
REINFORCED

TAKES DOWN IN A MINUTE
GRILL IS REPLACEABLE



GOLDBLATT JITTERBUGS®—These Jitterbugs® are made to take it. Because they are carefully reinforced to stay flat they stand up to everyday pounding on the job. Buy your Jitterbug® with your choice of our standard Round Hole Grill or the Cupped Mesh Grill that directs splashing mud away from your legs. All Jitterbugs® have an offset handle for perfect balance, easy all-day use.

Tamping with either of these two tools brings fine material and fat to the surface for fast, easy finishing, settles the larger aggregate to consolidate the slab for maximum strength.

Interchangeable handles on all Jitterbugs® let you quickly and easily change grills, saves the cost of buying a whole new tamper when your grill finally wears out. The standard Jitterbug® handle fits the 48", 46" and 36" models interchangeably. Four easy-to-remove bolts hold handle firmly to grill.

Rubber hand grips give you safe, sure handling that cuts down fatigue.

● ROUND HOLE

● **48" ROUND HOLE JITTERBUG® TAMPER**—48" x 6½"; weight lbs.16 585 M7... \$17.25

● **36" ROUND HOLE JITTERBUG® TAMPER**—36" x 6½"; weight 12½ lbs.16 587 M7...\$15.55

● EXPANDED STEEL



● **46" EXPANDED STEEL JITTERBUG® TAMPER**—46" x 8"; weight 16 lbs.16 777 M7...\$17.25

REPLACEMENT HANDLES & GRILLS FOR JITTERBUGS

SPARE 48" ROUND HOLE GRILL ONLY—8½ lbs. 16 586 M7...\$9.05

SPARE 36" ROUND HOLE GRILL ONLY—6½ lbs. 16 588 M7...\$7.50

SPARE 46" EXPANDED STEEL GRILL ONLY—Weight 6½ lbs. 16 778 M7...\$9.05

SPARE JITTERBUG HANDLE—Fits all Jitterbug grills listed above. 16 584 M7...\$8.75

RUBBER BOOTS



NEW

● **RUGGED RUBBER BOOTS**—An inexpensive boot that keeps you dry and comfortable in mud or water—all black, 16" high tops. Size 8 to 13. Order same size as your regular shoe size; no half sizes, order next size larger. Order by Catalog Number and specify size.

Size 8	09 450 H7...	\$8.80
Size 9	09 451 H7...	\$8.80
Size 10	09 452 H7...	\$8.80
Size 11	09 453 H7...	\$8.80
Size 12	09 454 H7...	\$8.80
Size 13	09 455 H7...	\$8.80

tamps and levels in one operation!

BRICK TROWELS

and

LEVELS

No matter where in the world you buy your Goldblatt Brick Trowel, you can tell the flex by the label attached to it. Every standard limber trowel has a white price label attached to it. Every EXTRA LIMBER trowel has a small ORANGE price label attached to it. Look for the EXTRA LIMBER label if you want a trowel that is alive in your hand.

Making trowels is like laying bricks, it's a one-at-a-time job. Your Goldblatt Trowel is precisely and patiently forged in one piece from high carbon steel. Then our trowel man personally selects a forging. Once it passes his personal inspection he slowly grinds it to perfect balance, taper and shape. You'll do better work with a Goldblatt Trowel.

Unconditional BRICK TROWEL GUARANTEE

Your money back if you're not completely satisfied with your Goldblatt Brick Trowel, even after you have used it. We guarantee our Brick Trowels to be perfect—free from any flaws in materials or workmanship. We will exchange your trowel for another Goldblatt Trowel of your choice if it does not

have the hang, feel, heft, balance or flex that you demand.

NOTE: This Guarantee is unconditional (including use) except that it does not apply to any tool that has been battered or altered in shape or hang by the buyer, or trowels that have been worn more than 1/2" in length.



NARROW HEEL LONDON

Heel is approximately 4 7/8" wide

With Wood Handle.....\$5.50 With Plastic Handle.....\$6.00

Size	Limber	Extra Limber	Size	Limber	Extra Limber
9 1/2"	01 601 M7	01 602 M7	9 1/2"	01 611 M7	01 612 M7
10"	01 603 M7	01 604 M7	10"	01 613 M7	01 614 M7
11"	01 605 M7	01 606 M7	11"	01 615 M7	01 616 M7
12"	01 607 M7	01 608 M7	12"	01 617 M7	01 618 M7

WIDE HEEL LONDON

Heel is approximately 5 5/8" wide

With Wood Handle.....\$5.50 With Plastic Handle.....\$6.00

Size	Limber	Extra Limber	Size	Limber	Extra Limber
9 1/2"	01 621 M7	01 622 M7	9 1/2"	01 631 M7	01 632 M7
10"	01 623 M7	01 624 M7	10"	01 633 M7	01 634 M7
10 1/2"	01 625 M7	01 626 M7	10 1/2"	01 635 M7	01 636 M7
11"	01 629 M7	01 630 M7	11"	01 645 M7	01 646 M7
11 1/2"	01 627 M7	01 628 M7	11 1/2"	01 637 M7	01 638 M7
12"	01 672 M7	01 673 M7	12"	01 647 M7	01 648 M7

PHILADELPHIA PATTERN

Heel is approximately 5 1/2" wide

With Wood Handle.....\$5.50 With Plastic Handle.....\$6.00

Size	Limber	Extra Limber	Size	Limber	Extra Limber
10"	01 650 M7	01 651 M7	10"	01 656 M7	01 657 M7
10 1/2"	01 640 M7	01 641 M7	10 1/2"	01 642 M7	01 643 M7
11"	01 652 M7	01 653 M7	11"	01 658 M7	01 659 M7
12"	01 654 M7	01 655 M7	12"	01 670 M7	01 671 M7

I-BEAM MAGNESIUM STRAIGHT EDGE LEVEL



● **MAGNESIUM STRAIGHT EDGE LEVELS**—The sides and edges of these extruded Magnesium 2 5/8" x 1 1/8" "I" Beam Levels are absolutely true and parallel. Vial unit can be adjusted or replaced.

4' MAGNESIUM LEVEL—4 plumb, 2 level vials.....07 184 H8...\$16.75

6' MAGNESIUM LEVEL—6 plumb, 4 level vials.....07 186 H8...\$26.25

STRAIGHT EDGE "JAMB LEVEL"



● **STRAIGHT-EDGE "JAMB" LEVEL**—Length is 6' 5 3/4". Greatest width 5". Thickness 1-1/16". A great time saver. Made of finest select Mahogany, thoroughly seasoned, weather proofed and highly polished. Four plumb vials and two

level vials read either end up... permanently set and protected by heavy lenses with moisture-proof sealer. Hand grip opening in center; two hang holes.

07 188 H7...\$27.00

SPARE HANDLES



Highly polished 6" hardwood handle has a heavy steel ferrule. For the man that prefers our quality wood handle.....01 102 M7...\$.60

New Tenite Plastic Handle with the shape demanded by masons. 5 1/8" long. Shatterproof. Won't mushroom. Warm and comfortable. Easy to mount....01 101 M7...\$.95

go hand in hand

The bubble vials on Goldblatt's conventional levels are made to extremely fine tolerances, with clear, easy-to-read markings, and a fast bubble. Accurately and carefully set in the stick. Ends of each vial are sealed to prevent leakers.

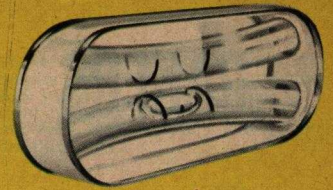

look at these features

- Laminated to prevent warping!
- Resin impregnated for weather-proofing!
- Laminations make level exceptionally strong!
- Locked on metal binding is very strong!

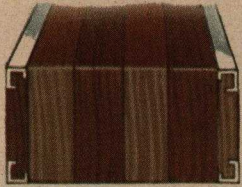

Laminated and impregnated with phenolic resins under great pressure, then fitted with strong metal bindings, Stay-True levels resist all job hazards better than any other levels made.



• STAY-TRUE LAMINATED LEVELS
—Here is the wooden level every mason will want to own because it is guaranteed against warping for two full years from the day you buy it!
Each Stay-True Level is made of many flawless strips of selected fine wood. These strips are impregnated with phenolic resins under great heat and pressure,

then laminated to form an exceptionally strong, completely waterproof, warp-proof and absolutely straight wooden level stick. It stays true under the worst job conditions, yet feels warm in the coldest weather.
A fine metal binding that holds up under direct blows and abrasion completes this fine stick. Six extremely accurate vials with fast

bubbles (four plumb and two level) are fitted to each stick.

GUARANTEED 48" STAY-TRUE™ LEVEL WITH HAND HOLES
01 263 M7...\$23.45

GUARANTEED 48" STAY-TRUE™ LEVEL WITH HAND GROOVES
01 264 M7...\$23.45

Mahogany levels are guaranteed against defects in materials and workmanship but not against warping; claims for broken vials or damaged binding must be made within 30 days of purchase.



This is the mahogany level preferred by expert masons everywhere. It is made of the finest straight grained Honduras mahogany—a pleasure to touch in any weather. The flawless brass binding is double-locked to the strong straight-grained stick, insurance that it will not come loose.



• BRASS BOUND MAHOGANY LEVELS—A careful mason insists on a Goldblatt mahogany level because he knows it takes a fine level to build plumb corners and to set brick, block and stone level and true. Each Goldblatt level is carefully selected from a stock of kiln-dried mahogany seasoned specifically for us. The flawless brass binding is meticulously locked to the stick. Then our own special

vials are precision-inserted using a master leveling machine of extreme accuracy.

Before it is end-capped with a brass cover to keep the ends protected each level is finished with a waterproof varnish that keeps moisture out of the wood. This care adds up to the most durable, accurate level you can use.

All levels fitted with four crystal

clear plumb and two level vials made of rugged, clear glass with crystal sharp etched markings; tough glass lenses protect the vials.

LEVEL WITH HAND HOLES
48"01 225 H7...\$15.60
LEVELS WITH HAND GROOVES
48"01 224 H7...\$15.40
42"01 223 H7...\$14.90
24"01 222 H7...\$ 8.50
18"01 221 H7...\$ 7.60



Flawless clear pine, completely encased in aluminum makes the sturdy, accurate, warp-proof and practically unbreakable Armor Clad level a once-in-a-lifetime purchase.



• ARMOR CLAD ALUMINUM LEVELS—Won't warp, bend or change shape in any way due to cold, heat or moisture. No other manufacturer makes a level like this wood level, 100% encased in a

rugged aluminum alloy. The clear pine core in this level adds strength, but holds weight down. 18" level has two plumb, two level vials; all others have four plumb, two level vials.

48" Armor Clad Level
07 194 M7...\$14.50
24" Armor Clad Level
07 192 M7...\$ 8.40
18" Armor Clad Level
07 190 M7...\$ 6.30



Beautifully finished mahogany is carefully bonded to this aluminum I-Beam that extends clear through the stick for utmost strength. Ends are aluminum capped to protect end-grain against moisture.



• I-BEAM REINFORCED LEVEL—This wooden level is reinforced with an aluminum I-Beam right down the middle so it can't warp. The I-Beam edges are precision ground flat and parallel; they are

tough, abrasion resistant, won't get out of true. Select, straight-grain mahogany bonded to the I-Beam makes this level as warm to your touch as any brassbound level. Fitted with four plumb, two

level extra-tough pyrex vials.
48" I-Beam Level w/Hand Holes
01 236 H7...\$19.89
48" I-Beam Level w/Hand Grooves
01 238 H7...\$19.89

48" SIZE ONLY • I-BEAM

BRAIDED LINES

STAY-TRUE™ NYLON LINES

GOLDBLATT BRAIDED NYLON LINE

—This rugged, easy-to-see nylon line is the first choice of masons and contractors all over the country. Made in three colors, green, white and yellow, this tough, tightly braided line tests up to 140 lbs. It can't snap, rot or break in normal use due to extreme moisture or dryness. Won't mildew. Once it's stretched taut, it stays taut—won't sag. Eliminates needless twiggling. Won't break when accidentally hit by mason's trowel. Our nylon line is now available in put-ups ranging from 1,000' to 100'.



● **100' DANDY DISC™ BRAIDED WHITE NYLON LINE**—Thin braided nylon line in a convenient, easy-to-use plastic disc. Keeps line clean, unsnarled; provides a simple way to store it between jobs. Each Dandy Disc contains 100' of top quality nylon braided line that tests over 100 lbs. Highly visible. Discs are connected so you can buy any length up to 1000' in this handy put up. White only.....
.....11 270 M7...\$1.25

IN GREEN, WHITE, OR YELLOW

● **250' WINDER BRAIDED NYLON LINE**—Our fine nylon line on a special hardwood winder with metal cut-off. No hunting for a knife or hacking at the line to cut it if it's on a Goldblatt Cut-Off Winder.
250' White.....11 236 M7...\$2.97
250' Green.....11 237 M7...\$2.97
250' Yellow.....11 238 M7...\$2.97

● **HARDWOOD WINDERS ONLY**—Envelope of 4 winders (no line).....11 260 M7...\$.95

250' WINDER

500' &
1000'
TUBE

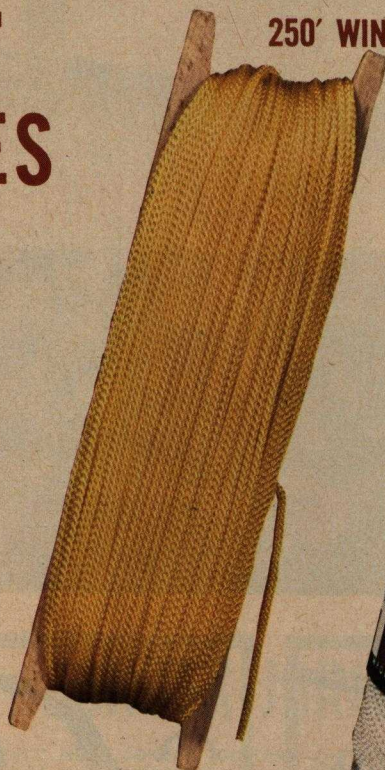

IN GREEN, WHITE, OR YELLOW

● **500' TUBE BRAIDED NYLON LINE**—
500' White.....11 240 M7...\$4.95
500' Green.....11 241 M7...\$4.95
500' Yellow.....11 242 M7...\$4.95

IN GREEN, WHITE, OR YELLOW

● **1000' TUBE BRAIDED NYLON LINE**—
1000' White.....11 243 M7...\$9.45
1000' Green.....11 244 M7...\$9.45
1000' Yellow.....11 245 M7...\$9.45

LINE HOLDERS

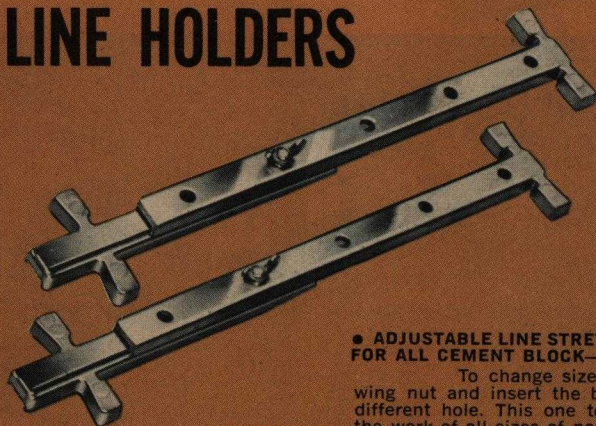

ADJUSTABLE

● ADJUSTABLE LINE STRETCHERS FOR ALL CEMENT BLOCK—

To change sizes loosen wing nut and insert the bolt in a different hole. This one tool does the work of all sizes of non-adjustable stretchers. Has handy posts to wind your line on when not in use. Quality made of cast aluminum. Per Pair...01 247 M7...\$2.50

A PAIR FOR ANY SIZE

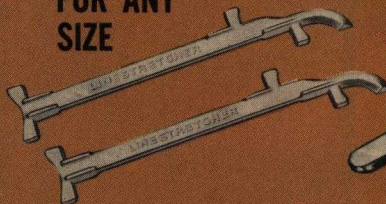

● **LINESTRETCHER FOR USE ON CEMENT BLOCK**—A better method of raising the line between key course blocks. Stretches line tight as you want. Use the linestretcher for a storage reel when not in use on the wall. Four sizes. Per Pair
For 4 to 6" blocks 01 243 H7...\$2.20
For 6 to 8" blocks 01 242 H7... 2.20
For 8 to 10" blocks 01 241 H7... 2.50
For 8 to 12" blocks 01 246 H7... 2.50

CORNER BLOCKS

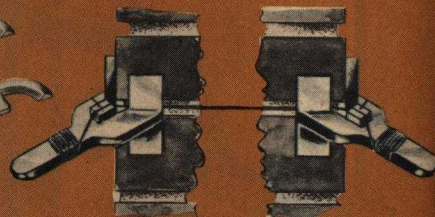

● **BRICKLAYER'S CORNER BLOCKS**—These extremely strong but light-weight aluminum corner blocks grip the wall tightly; will not break in use. The line wraps around the stem, goes through the slot at the forks, then between the brick and the groove on the flat face of the block. Line pull holds the block tightly at right angles to the line. The 2 3/4" stem gives you a sure grip when you move the line up. Per pair.....01 250 M7...\$.95

BONDED BRAIDED

TWISTED LINES

TRIPLE TOUGH

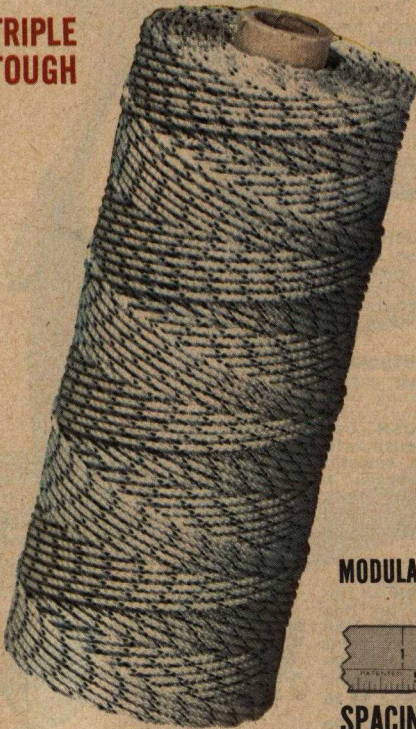

ORDER IN GREEN, WHITE, OR YELLOW
350' TUBE

● **350' TUBE TWISTED NYLON LINE**—This #15 twisted nylon line is specially treated to hold knots. For the man who knows the advantage of nylon line—and wants it—but does not need our specially braided line. This lower cost line comes in ¼ lb. tubes with over 350' per tube. Tests over 100 lbs.! Outwears cotton line many times. A good buy at only \$1.10 a tube.

350' White.....11 247 H7...\$1.10
350' Green.....11 248 H7...\$1.15
350' Yellow.....11 249 H7...\$1.15



SPACING TAPES



SPACING



● **BONDED BRAIDED NYLON LINE**—Wears far longer, is far stronger than any other mason's nylon line because it's hot dip Nylon impregnated and coated for extra toughness. This exclusive Goldblatt line is worth more to you than the few cents extra it costs because you'll replace line less often, make big savings in the long run. Use this line to add a big plus sign to every advantage you expect from Nylon Line: strong, tough, tightly braided, it won't rot, mildew or sag. 500' Tube...11 252 M7...\$5.75

● **MASON'S MODULAR STEEL TAPE**—Carry this steel tape with you in your pocket. Has modular markings for all common brick. Extends to full 10' for maximum usefulness. Blade rolls easily into chrome plated case. Has black feet, inches, modular markings on white blade.....01 515 H7... \$3.50

● **MASON'S STEEL SPACING TAPE**—Same tape as above, but mason's spacing markings. Feet, inches on one edge of blade, brick spacing on the other.....01 516 H7... \$3.50

SPACING RULES

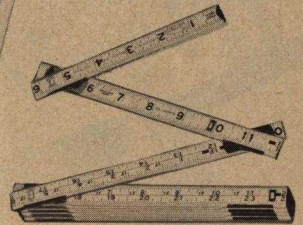

"COURSE COUNTING"

● **WOOD "COURSE COUNTER" SPACING RULE**—Small numbers in red, printed at right angles to regular coursing numbers tell you how many courses you've marked off or laid up. Made of straight grain hardwood, ½" thick (twice as thick as ordinary rules). Won't bend when you extend it upward. Plastic coated so numbers won't wear off. Joints lubricated for life. Gives ten course spacings on one side; has inches, eighths and 16ths on other side. Six feet long.

01 167 H7...\$3.00

MODULAR

● **WOOD MODULAR "BUTT" RULE**—First section is short for butting rule on first 16" module. All legs have square ends. Every joint opens on even numbers. Fine for 6" or 12" glass blocks. Six scales. Made of straight grain hardwood ½" thick (twice as thick as ordinary rules). Won't bend when you extend it upward. Gives modular spacing on one side of stick, feet, inches and eighths and 16ths on the other.

Extends to 6'.....01 512 H7...\$3.00

● **BRICKLAYERS' LINE PINS**—These fine quality pins are stiff and plenty long enough to hold the line securely. Made of tempered tool steel!—The best for this job. Dim.: 5/8" x 1/8" x 7". Envelope of 4 Pins. Envelopes can't be broken. 01 258 M7...\$.99

LINE PINS



● **SNAP-OVER LINE TWIGS**—Precision-made of clock spring steel. They snap completely around mason's line, eliminate sagging. Full 4" long and 5/8" wide. Keep plenty of them handy! Envelope of 14 Twigs. Envelopes can't be broken. 01 256 H7...\$.99

LINE TWIGS



● **TENITE PLASTIC LINE BLOCKS**—The first successful version of the old reliable wooden line block back at a terrific price. This dense Tenite block will not split, clings to the wall like glue, will last and last. 4 1/4" long. Pair Tenite Line Blocks01 249 M7...\$.75

PLASTIC

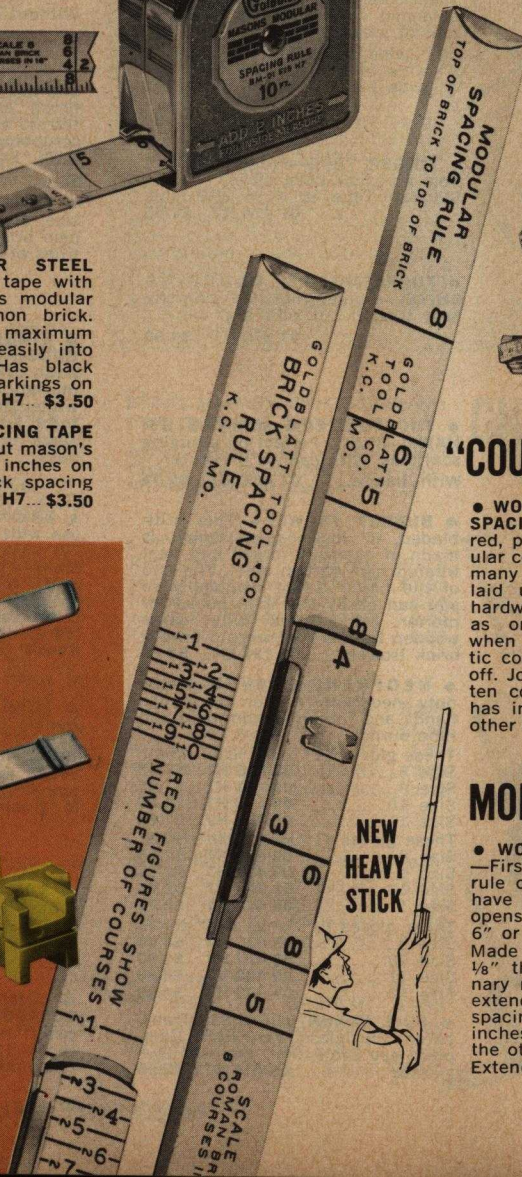

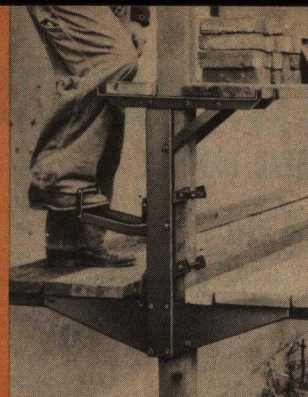
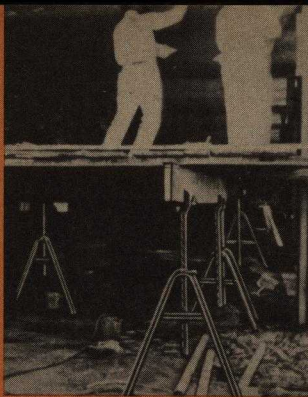

● **HEAVY DUTY ADJUSTABLE TRESTLES**—Here is a trestle that makes scaffolding jobs move faster and safer. You can trust Goldblatt TROUBLE SAVER Scaffolding. Each trestle supports more than a ton—safely. Made of high-test rail carbon steel, they will not bend in normal use. Use no tools to adjust (two jacks, above, make a trestle). Standard **Handle Nuts** lock all adjustments. Raise or lower the jack with one fool-proof adjustment. No tools needed. They go up fast; come down easy.

All prices F.O.B. Uniontown, Pa.

Size #2 for work heights 7½' to 7¾'; 4 adjustments; weight one trestle, 15½ lbs. 07 410 E2...\$13.05

Size #3 for work heights 8' to 9'; 5 adjustments; weight one trestle, 21½ lbs. 07 411 E2...\$14.05

Size #3½ for work heights 8½' to 9½'; 5 adjustments; weight one trestle, 24½ lbs. 07 412 E2...\$14.85

Size #4 for work heights 9' to 10¼'; 6 adjustments; weight one trestle, 28 lbs. 07 413 E2...\$16.10

Size #6 for work heights 10' to 12'; 9 adjustments; weight one trestle, 53 lbs. 07 414 E2...\$20.50

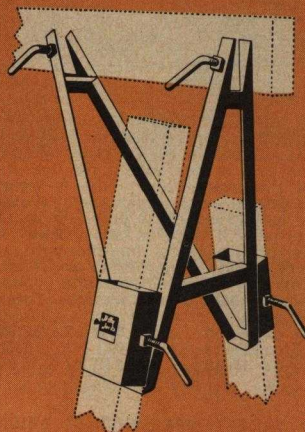

● **JIFFY JACKS**—Most versatile scaffold equipment you can buy—no matter what you pay. And costs less than any other. Why have a dozen sizes of trestles, when most jobs call for only one size at a time? Buy these Jiffy Jacks. You use only one basic unit. Get any height you want from 2' to 12' simply by changing 2 x 4 legs. Cut legs to approximate height, then slide into Jiffy Jack to exactly the height you want. Lumber is 100% reusable. Absolutely the best units you can buy for uneven ground, ramps, stairways, etc. Each leg can be a different length in order to level scaffold. Lock positively. Safe and sturdy. Two Jiffy Jacks Make A Trestle. Weight 22 lbs.

Pair Jiffy Jacks
F.O.B. Kansas City.

07 554 E3...\$15.15

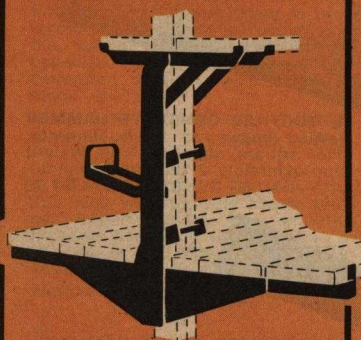

\$49.90 a pair

● **MASON'S SCAFFOLD BRACKETS**—Lay 25% to 40% more bricks from this scaffold because: you never stoop to reach material; you never stop to rebuild scaffold; you set up in as little as seven minutes per unit.

The scaffold rises on 4 x 4 uprights (made of 2 x 4's) tied to the wall by swivel joint top braces. You pump the foot lever to go up, turn the hand crank to descend. Masons work on the inner platform; laborers on the outer platform; materials go on the center platform. Perfect on uneven ground because uprights work independently. Meets most state safety codes. Holds at least 2,000 lbs.

Two Complete Scaffold Brackets with Materials Platform Supports and Top Braces, F.O.B., Paterson, N.J.11 411 E2...\$49.90

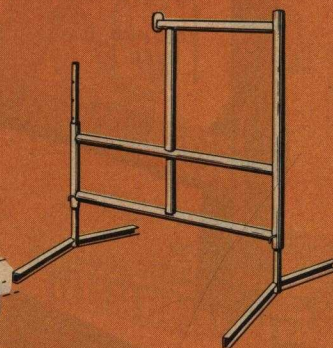

\$19.95 Each

● **SCAFFOLD WITH MATERIALS PLATFORM**—This low-cost, adjustable mason's scaffold has a hip high materials platform. The working and materials platforms are each 25" wide. Working level adjusts upward from 1' 6" to 4' 6" in 2" stages; materials level adjusts from 3' 6" to 6' 6". For extra height, turn panels so workmen stand on the materials level, toward the wall. Use bottom cross braces to get as low as 6" off ground level.

Easy to use pin type adjustment can't get out of order. Made of 1½" welded tubular steel, panels are 4' x 3', knocked down, weigh 37 lbs.

One Panel, F.O.B. Fort Worth, Tex. 07 584 E2...\$19.95

SIX PANELS OF SCAFFOLD 35' OF WALL—F.O.B. Fort Worth, Texas. 07 588 E2...\$116.00

● **SELF - DRILLING SCAFFOLD PLANK REINFORCING RODS**—Save split planks with these easy-to-use rods. With your drill, drill rods through the plank as shown in the illustration; twist the projecting end of the rod with a bending tool; then hammer it into place.

Rods are guaranteed to last the life of your planks. When planks shrink, a few blows from your hammer tighten the rods again. A centering guide and bending tool are the only special tools needed. The centering guide helps you drill through the center of the plank. The bending tool turns the sharp end of the rod back into the plank. bundles of 100 only.

100 10" plank rods 07 451 E7...\$5.95

100 12" plank rods 07 452 E7...\$5.95

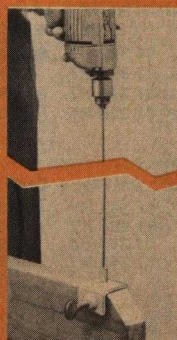

Centering Guide & Bending Tool 07 449 E5...\$2.95

SELF DRILLING PLANK RODS

● **BOLT ATTACHED BRACKETS**—Made of rail carbon steel, they will not bend or break. Fold compactly for storage. Put them up or take them down in a fraction of the time required to build even a make-shift wooden scaffold. Bolts through sheathing and 2x4 across studs.

SCAFFOLD BRACKETS—All scaffold brackets shipped F.O.B. Uniontown, Pa. Sold only in sets of 12. Price and weight shown are for sets of 12 scaffold brackets.

Lgth. Wt. Per 12 Stock No. Price For 12

3' 165 lbs. 07 578 E2 \$70.60

3½' 200 lbs. 07 579 E2 \$76.25

LEGAL IN ALL STATES

SCAFFOLD BRACKETS



Sold only in sets of 12.

GOLDBLATT'S STAY-TRUE™ STORY POLES

STORY POLE FITTINGS

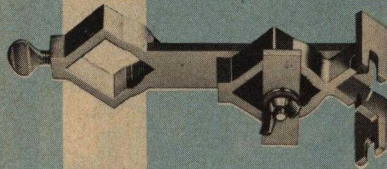

For veneer work, top fitting is used with Top extension. To plumb pole, loosen thumbscrew and tighten in position. Slots in fitting hold nails.

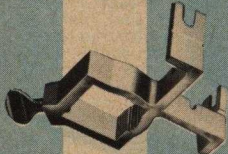

Middle fitting is used to hold line. Can be positioned anywhere on pole with thumbscrew.

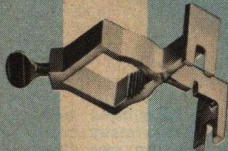

Lower fitting rests on foundation with nail through slots diagonally, or nails or clips to foundation or existing masonry.



Long nail and wall clip are supplied with each set of Stay-True guides to attach bottom fitting to work.

● **STAY-TRUE® STORY POLE FITTINGS**—This easy-to-use set of fittings is so versatile you can use it to make your own masonry guides for solid or veneer masonry. Use the fittings on your choice of 1½" O.D. square steel tubing, standard 1¼" pipe, 1½" x 1½" O.D. Angle or 1⅝" O.D. square lumber. We recommend the square steel tubing as best. One set of fittings includes three interchangeable castings (top fitting, line holder, base fitting), cast top extension, top pressure plate, 7" x 3/16" duplex nail, wall clip, carriage bolt, wing nut and thumbscrews. Add a pole and you have a masonry guide.

The Stay-True fittings system is more useful than any other because any guide works on inside corners, outside corners or along the wall as an intermediate pole just by changing the position of the fittings.

Cast in a durable aluminum/magnesium alloy, Stay-True fittings are strong but lightweight, won't rust. All bolts and thumbscrews are cadmium plated. Complete instructions included with each set.

One Set Stay-True Fittings To Make One Masonry Guide
11 710 H5...\$11.95

Five Sets Stay-True Fittings To Make Five Masonry Guides
11 711 H5...\$58.25

● **STAY-TRUE™ POLES** — The finest, simplest masonry guide system we have ever seen. We believe you will get 20 to 30 per cent more production with these easy-to-set-up poles than you do if your crew does not now work with a masonry guide system. If you now use a masonry guide system, you should be able to increase production and cut costs because of the amazing advantages and simplicity of Stay-True Story Poles.

ONE POLE DOES ALL—Anyone who's ever considered buying masonry guide systems knows what an advantage this is. You buy only one kind of pole. You will never be caught with one too many outside poles and short one inside pole. A Stay-True pole sets up anywhere—on an outside corner, on an inside corner or somewhere in between for tailing the lead, or twiggling. As the wall progresses, raise the pole to reach any height.

SETS UP EASILY—Two nails hold the top fitting to sheathing or insulation board. One single adjustment puts the pole in bricking position. A thumbscrew holds the pole to the top fitting. You adjust this one thumbscrew to plumb pole. Bottom of the pole rests on foundation or is held tightly against it, depending on where pole is used. The illustrations below show details.

By removing thumbscrew you can take pole down overnight; set it up instantly in the morning. Because it is just 6' long, any mason of normal height can set up pole without a ladder. Because it is short, it can be used under low overhangs. This also makes it easy to carry in your car.

FOR SOLID MASONRY—Just turn the top fitting around and attach braces to "ears."

BUILT TO TAKE IT—Of all aluminum construction. All fittings are carefully Heli-arc welded. The pole part is made of a special extrusion that has a spine running down the middle for extreme rigidity. No pull of the line will ever bend this pole—and when properly erected, it will not pull out of plumb no matter how tightly you stretch the line. Because it is made of aluminum, the Stay-True Story Pole will not rust or warp. Should last indefinitely with minimum care.

"KEYED ON" LINE HOLDERS—Three cleverly designed line holders remain on the pole at all times. Except when line tension holds them in place, they are free to move up and down the pole. On outside corners, two holders carry the line. On inside corners, or along the line, two holders become bottom pole fittings. The third holder guides the line around the corner or acts as a twig. These line holders can't fly off and injure

your masons. They stay on the pole where they are needed.

● **FLAT SPACING TAPES FOR POLES**—This 5' 9" flat tape has standard spacing on front, modular spacing on the back. Clip it to Stay-True pole with three phosphor bronze clips or tape it to your own metal or wood pole—then set to the mark just as you would with any rule or tape. Ends time-consuming and hard-to-read pencil marking; increases production. Won't curl or snap back.

Spacing Tape. 11 597 H7...\$2.45
Three Clips (fit Stay-True Poles Only).....11 598 H7...\$1.05

your masons. They stay on the pole where they are needed.

STAY-TRUE STORY POLE ADVANTAGES—With these Story Poles, you no longer build time-consuming leads or corners. Once the pole is plumbed, you almost entirely eliminate plumbing the work. These corner poles will cut down human errors—eliminate hogs in the wall. A wise contractor will use both men and materials to better advantage with Stay-True Story Poles.

One Stay-True Story Pole
11 596 E5...\$34.50

Six Stay-True Story Poles
(207.00 Value)... 11 599 E5...196.65

INSIDE CORNERS

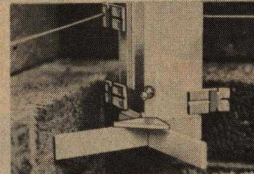

Three line holders "lock" to pole. On inside corners or on the line, one carries line, two brace on foundation.

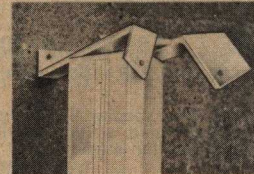

On inside corners or on the line, pole reverses, nails to sheath board with flat end of fitting.

OUTSIDE CORNERS

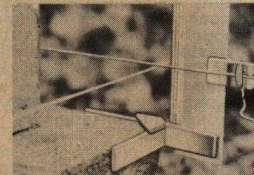

Pole bottom rests on foundation. Leaves only ½ sq. in. to tuckpoint. Remove, replace pole at any time.

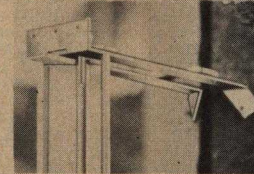

Two duplex nails hold top fitting in place. Thumbscrew allows easy plumbing or instant removal of pole.

SPACING TAPE

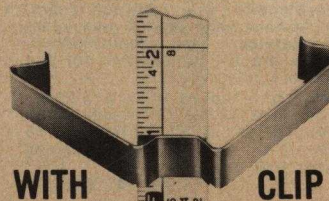

WITH CLIP

EXCLUSIVE FEATURES

- All Aluminum Construction
- All Joints Welded
- Extremely Light weight
- Line Holders "Keyed" to Pole
- One Man Sets Up
- One Fitting Plumbs Pole
- Works with Any Height Construction
- Tool and Strike Without Moving Pole

TARGET MASONRY SAWS

14" HEAD PORT-A-SAW

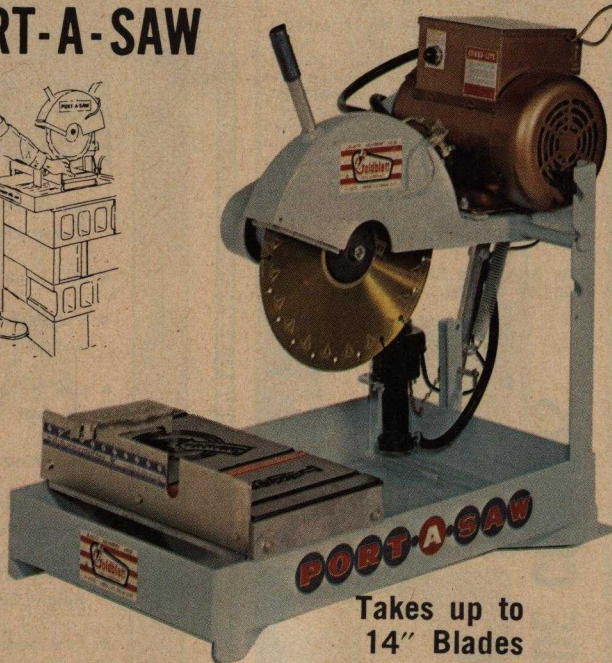
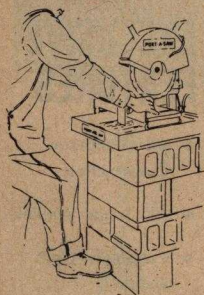

Takes up to
14" Blades

● **GOLDBLATT PORTABLE MASONRY SAW**—One man loads this powerful masonry saw into the trunk or back seat of a car. It goes where you go—on the scaffold, in a basement or works off the tail gate of a truck. Cuts wet or dry. Uses 14" blades. Adjusts instantly to cut 2" brick, 4" tile or 8" block. Your choice of 1½ hp or 2 hp motor equipped with finger tip switch to change from 220 to 110 volts. Full size, twin V-belt drive delivers full motor power to the blade through sealed bearings—the same size as those on our 14"

Guard Lite motor warns you of overheating, overloading or low line voltage.

saw. The special lightweight alloy cutting head weighs 11 lbs. less than similar steel heads.

The light alloy conveyor cart is guaranteed to last the life of the saw. The heavily reinforced reservoir pan has the highest capacity water pump ever used on a masonry saw. It delivers more than enough water for wet-cutting with diamond blades. Portable Wet Cutting Saw with Dual Voltage Switch. Blade not included in prices.

1½ hp11 410 E3....\$329.00
2 hp11 408 E3.... 349.00

14" HEAD THRIFTY/MATIC

Takes up to
20" Blades

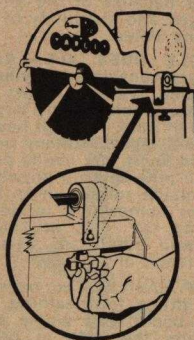

NEW! QUICK MOUNT
BALL BEARING HEAD
ONLY ON TARGET SAWS

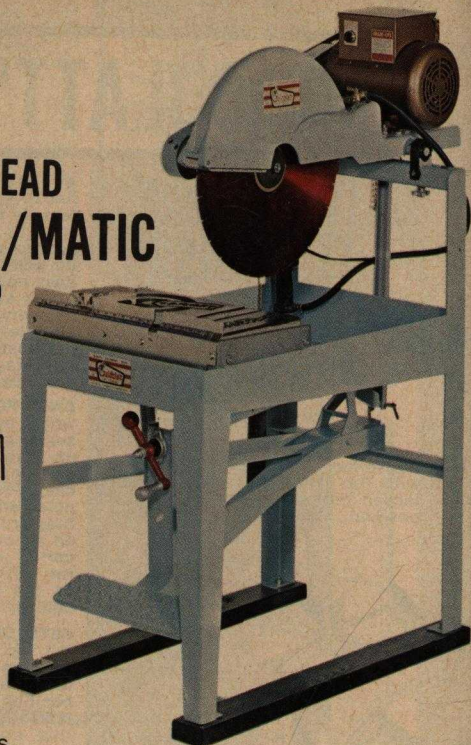

● **GOLDBLATT THRIFTY SAW**—Choose this low cost saw for fast, accurate cutting combined with long life. Has more features than other saws costing up to \$50.00 more. Check these features, then order: Head takes 14", 18" & 20" blades; cuts through an 8" block in one pass with 20" blade; a flip open head makes split second blade changes easy; twist of a crank adjusts head angle to make different cuts or use different size blades; Guard-Lite warns you before operator damages motor through over-loading or low line voltage; dual voltage switch; 24" patented life-time conveyor cart with adjustable guide for 45° and 90° cuts. A slope back water reservoir increases water capacity and flexible drain hose

speeds clean out; a simple belt tightener and over-all husky construction make this the saw that will give you long lasting, trouble free service for years.

All Parts Guaranteed against defects of materials or workmanship; pump guaranteed unconditionally for one year.

Blade not included in prices.

20" Blades may be used on all Masonry Saws listed below.

14" Wet Cutting Saw (3 hp)
11 386 E3....\$545.00

14" Wet Cutting Saw (5 hp)
11 387 E3....\$595.00

To use 18" or 20" blades, specify blade size and order Hinged Safety Guard11 385 E3....\$5.00

MASONRY CUTTERS

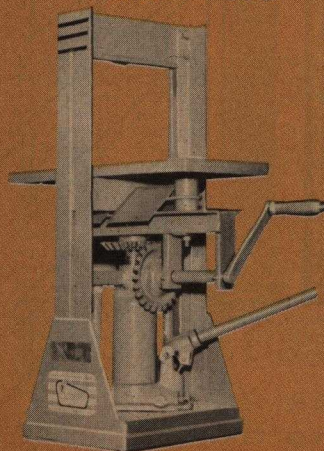

● **LOW COST 9" HYDRAULIC SPLITTER**—Here's a rugged hydraulic splitter anyone can afford. This low cost splitter has all the high cost features you expect in a splitter from Goldblatt. Makes instant cuts on all kinds of stone, block, brick. Has fast adjustment crank located right next to the pump handle for easy operation. The rugged, but light weight, ram develops more than enough pressure to split the hardest stone. Just adjust the hand crank to approximate stone thickness, give a couple of "pumps" with the handle and you've got a perfect split. After the cut, just back crank off one turn and you are ready for the next cut. After series of cuts, let ram down with easy turn of release valve. Made of rugged steel, these units will last for years. Super-hard edge blades give years of service. Low maintenance. These are the units that are the mason's favorite

Cuts stone up to 8" x 6", 25¾" high on a 12" x 10" base. Stone table, 13½" x 8¾". Weight, 66 lbs.11380 E3....\$169.00
Extra Pair Blades
11 390 E4....\$ 26.00

SUPER STONE SPLITTER

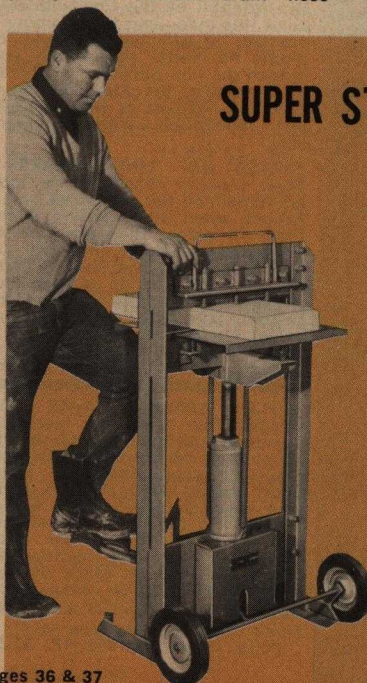

● **SUPER SPLITTER**—These husky, powerful stone splitters are wheeled. With foot operated hydraulic pumps you put your entire body weight to work to develop up to 19 tons of cutting pressure; split the hardest stone quickly and cleanly. Hold down feature keeps cut material safely on the table. Exclusive Hardege blades are long wearing. Wide base makes these machines very stable. Bronze bushings, brass wipers and low oil volume insure low upkeep.

● **SUPER 10**—Throat, 10 x 8¼"; blade height 40"; shipping wt., 165 lbs.11 375 E3....\$233.00
Extra Pair 10" Blades
11 376 E3....\$ 30.00

"Have used your tools for over 15 years. They outlast others."

Eugene Dowdell
617 2nd St. W.
Birmingham 4, Alabama

ORDER BLANK: In Center Fold

IMPROVED MASONRY BLADES

for Hand Saws Masonry Saws

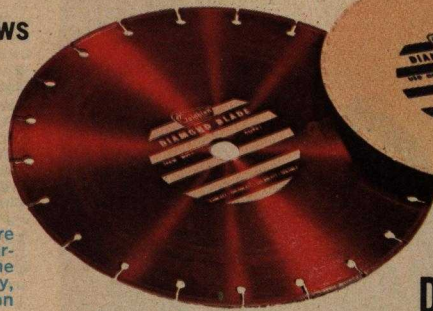
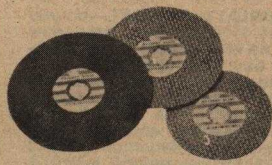

LOW COST INTERLOK DIAMOND BLADES

Lower Prices Than Ever Before!

All Goldblatt Masonry Blades are powerfully reinforced with Fiberglass. All are guaranteed to cut the materials listed for them cleanly, quickly and efficiently. Satisfaction Guaranteed or Your Money Back.

● **SHATTERPROOF ABRASIVE BLADES**—Made for fast production cutting on your big saw, these wheels have a layer of Fiberglass molded into each side, making them virtually unbreakable. Each blade carefully made with the right amount of abrasive to cut the material you specify. These blades combine low cost with fast cutting and long life.

● **HARD MATERIALS BLADES**—Cuts these BRICKS: Glazed, Shale, Stiff Mud Face, Vitreous Face and Acid Proof Firebrick; these TILES: Glazed Vitreous, Manganese, Quarry, Roofing, Terra Cotta Extruded, Unglazed Vitreous and Wall Tile; plus these STONES: Limestone, Marble, Slate and Granite. All Blades are Shatterproof.

Ctn. of ten 12"....11 220 H6...\$48.00
One 12" blade...11 511 H6...\$ 6.20
Ctn. of ten 14"....11 508 H6...\$63.50
One 14" blade...11 509 H6...\$ 7.25
Specify material you intend to cut!

● **MEDIUM HARD MATERIALS BLADES**—Cuts Common or Cinder Brick; Flagstone and Dense Sandstone; these BLOCKS: Glazed, Haydite, Sand & Gravel and Concrete Pre-cast; these TILE: Common Backup, Glazed Semi-Vitreous, Cast Terra Cotta; TRANSITE.

Ctn. of ten 12"....11 221 H6...\$48.00
One 12" blade...11 507 H6...\$ 6.20
Ctn. of ten 14"....11 506 H6...\$63.50
One 14" blade...11 505 H6...\$ 7.25
Specify material you intend to cut!

● **SOFT MATERIALS BLADES**—Cuts Cement and Dry Press BRICK; Pumice BLOCK; Austin, Porous Sandstone and Tufa-STONE: Cast, Dry Press, Insulating and Silica.

Ctn. of ten 12"....11 222 H6...\$48.00
One 12" blade...11 504 H6...\$ 6.20
Ctn. of ten 14"....11 502 H6...\$63.50
One 14" blade...11 501 H6...\$ 7.25
Specify material you intend to cut!

● **SHATTERPROOF HAND SAW BLADES**—Fast cutting and virtually unbreakable because Fiberglass is molded onto both sides of the blade for double safety and low cost.

Specify these three important points on your order:

1. Make of your saw.
2. Wet or dry cutting. If you don't say, we ship dry cutting.
3. Material you will cut.

Carton of ten 6"x1/8" blades
11 536 H6...\$24.00
One 6" blade Only
11 516 H6...\$3.00

Carton of ten 7"x1/8" blades
11 537 H6...\$28.00
One 7" blade only
11 517 H6...\$3.40

Carton of ten 8"x1/8" blades
11 538 H6...\$32.50
One 8"x1/8" blade only
11 518 H6...\$3.85

Carton of ten 8"x1/4" blades
11 562 H6...\$46.10
One 8"x1/4" blade only
11 552 H6...\$5.12

Carton of ten 10"x1/8" blades
11 533 H6...\$48.75
One 10"x1/8" blade only
11 522 H6...\$5.75

● **SEGMENTED DIAMOND BLADES**

—Because segments allow water to flow into cut, the blade runs cooler, cuts faster. The segments also cut with sides as well as edge, giving you more cuts per dollar from these blades. For low cost production cutting, order one of the blades below. You must specify material to be cut and make of saw when you order diamond blades. 20" blades cut 8" concrete block in one pass.

Hard Materials Blade—cuts hard materials listed at left. WET ONLY!
14" Segmented 11 548 E3...\$149.00
20" Segmented 11 571 E3...\$309.00

Medium Hard Materials Blade—cuts hard materials listed at left. WET ONLY!

14" Segmented 11 549 E3...\$149.00
20" Segmented 11 572 E3...\$309.00

Soft Materials Blade—Cuts soft materials listed at left. WET ONLY!
14" Segmented 11 550 E3...\$149.00
20" Segmented 11 574 E3...\$309.00

BRICK TONGS

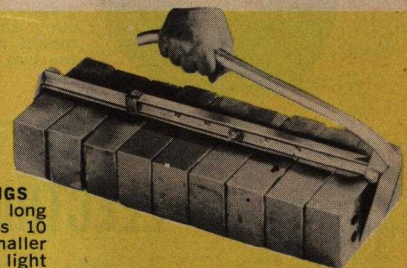

● **BRICK HANDLERS OR TONGS**

A heavy duty tool built for long service. Carries as many as 10 brick. Adjusts to carry a smaller number of brick. Made of light rugged metal alloy, these tongs save time and money. Can't damage bricks. No maintenance.
11 280 H7...\$4.95

MIDGET HELPER

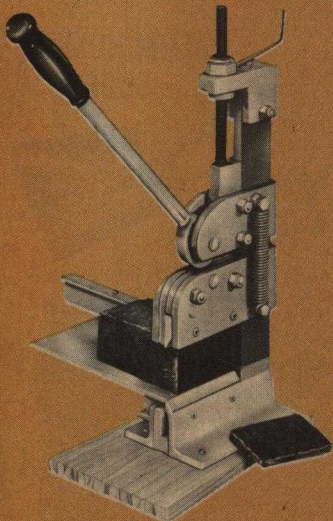

● **ELMER'S MIDGET HELPER**—At last you can take a masonry splitter with you on the scaffold—take the strain off your favorite trowel! This little 26" high, 26 lb. beauty has a throat opening 5" high to take most masonry units on edge—the 4 1/2" wide blades cut most brick now in use.

One easy movement of the handle shaves as little as 1/4" off the ends of a brick. To make sure your cuts are accurate, a 12" rule and square is built right into the tool. This little machine is causing a revolution in masonry cutting. Every mason can use one. Ruggedly built, it has no hydraulic parts to leak or worry about.

Carefully calculated cam and lever action multiplies the strength in your good right arm by 1,000 to split brick instantly with practically no effort. The long-lasting blades of the same high strength, hardened steel alloy used in big splitters replace easily. Guaranteed. Elmer's Midget Helper

11 382 E3...\$95.50

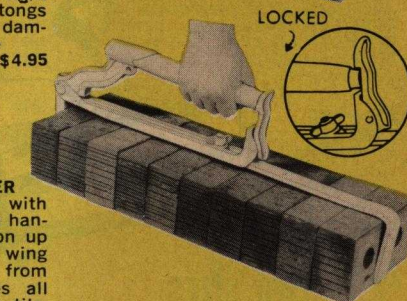

● **THE FULLER BRIKARIER**

Locks open to unload quickly with one hand. The latch holds the handle down. Increases production up to 50% with less effort. Large wing nut makes fast adjustment from 6 to 10 bricks easy. Handles all kinds of brick and building tile. Made of rugged malleable iron. Handle is wood...11 281 H7...\$7.10

HAND SPLITTER

● **BRICK, STONE & TILE CUTTER**

—Goes anywhere with you—even on the scaffold. A solid whack with a 2-lb. hammer (or heavier) cuts brick, block or stone up to 8" wide, 4" high. Entire tool is carefully machined tool steel, painted with rust resisting paint. Blades are tough, tempered steel. Overall height, 8 3/4". Base, 11" x 4" x 1/2". Wt. 15 lbs...11 313 E5...\$19.95

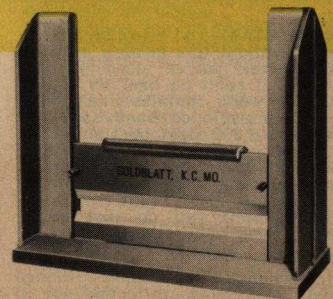

GOLDBLATT "NUGGET"

CUTS MASONRY,
CONCRETE, METAL

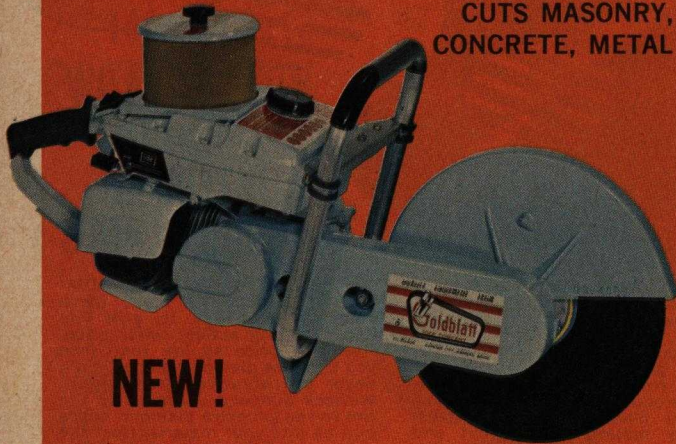

NEW!

● **GOLDBLATT NUGGET**—If you don't let it scare you, this new saw is one of the most useful tools you can buy. It cuts concrete, masonry and steel with ease. And only Goldblatt Nugget works where you need it deep in the dust of concrete and masonry sawing.

The special air cleaner on our 6.3 cu in, 6.5 hp gas engine keeps it going on the dustiest of jobs where others fail. The whole rig weighs only 29¾ lbs and once you get used to handling this 30½" long, 14" wide, 12" high bundle of dynamite, it's the most useful saw you'll ever own. With a 12" abrasive blade, you can cut masonry, concrete or steel dry; with wet-cutting attachment and a diamond blade, you wet-cut masonry or concrete.

This is the only gas-powered hand saw we know of that takes the constant abuse of masonry and concrete cutting. And it is packed with convenience features you need—

safety governor controls engine speed, perfect balance for easy handling, destrokng port for easy starting, spark arrestor muffler for safety, adjustable blade guard for cutting in any position, and most important: it's built with extra heavy duty bearings and 1" shaft to take extra high speed 12" diameter blades. Of course it's guaranteed: satisfaction or your money back.

Blade not included in price.
07 997 E4...\$324.95
Wet Cut Kit07 998 E4...\$ 14.95

● **NUGGET ABRASIVE BLADES**—Specially reinforced 12"x½" wheels for high speed cutting at up to 4,500 rpm. Made specifically for use with the Goldblatt Nugget saw, above.

One 12" Nugget Blade
07 415 H6...\$ 7.65
Ctn of 10 Nugget Blades
07 418 H6...\$69.50

7" REINFORCED GRINDING DISC

NEW!

For Right Angle Grinders



● **SAFETY GRINDING DISK**—Fits your right-angle drive grinder or flexible shaft grinder to take down high spots and grind off form marks. With five layers of fiberglass bonded into the disk, makes cups wheels old-fashioned. Speed mount adaptor is built right into the cup disk. 7"x1"x½"

07 790 E6...\$12.80

TUCKPOINTER'S

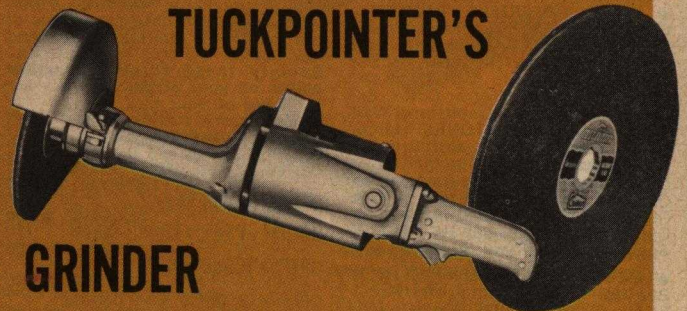

GRINDER

● **TUCKPOINTER'S GRINDER**—The best tuckpointer's grinder. Fast, economical, reliable. Penetrates 2½" with 8" wheel turning at 4000 rpm to clean out all loose mortar with absolute control. Made by Milwaukee Electric Tool. Double row ball bearings in forward handle housing give rigid wheel support. All ball bearings throughout. Operates on AC or DC 115 volt current. Large easy-to-hold handle grip and fully enclosed, dust tight, heavy duty switch with lock button for continuous running. Extra large

steel wheel guard for safety. Comes with 8" x ½" wheel and Blade Guard11 551 E2...\$105.00

● **TUCKPOINTER'S COST-CUTTER BLADES**—The best blades for all tuckpointer's grinders. ¼" thick blade gives good, husky bite, speeds work; 8" diameter gives you deep cut. Long-lasting Goldblatt Shatterproof Cost-Cutter Blades give you longest blade life. 8" x ¼" Blade.....11 552 H6...\$5.12
Carton of 10.11 562 H6...\$46.10

8" or 16" ELECTRIC WELLSAW

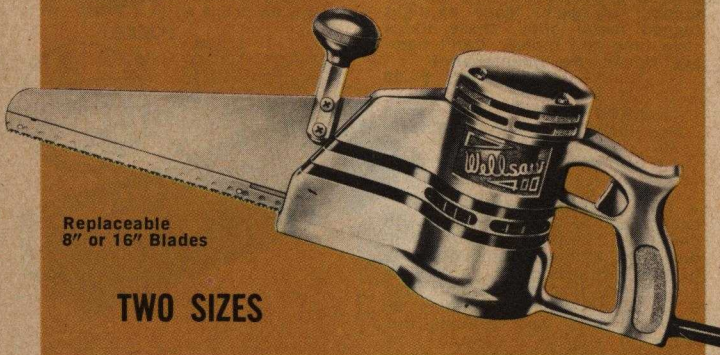

Replaceable
8" or 16" Blades

TWO SIZES

● **WELLSAW**—You won't be able to work without this general purpose saw after you've used it two weeks. It can't be beat for rough-cutting work. Handles like a regular old-fashioned hand saw, but delivers 8,000 rigid 1½" strokes a minute on 110 V ac/dc current with no kick, pull or whip. You can use full length of the 8" blade to cut beams, make blind cuts without binding and do just about every other hand saw job.

Interchange replaceable blades with 8, 12, 16 teeth to the inch in a matter of minutes.

A saw of this kind cut an entire house in half in 30 minutes through nails, plaster and all. When a blade gets damaged, replace it with a new one. Does numberless heavy duty cutting jobs easily.

8" Wellsaw07 778 E6...\$88.55
8-Tooth, 8" blade
07 779 E6...\$ 95
12-Tooth, 8" blade
07 782 E6...\$ 95
16-Tooth, 8" blade
07 786 E6...\$ 95
16" Wellsaw07 785 E6...\$99.95
8-Tooth, 16" blade
07 788 E6...\$ 95

SHOVELS

Forged, one piece,
Lightweight, Reinforced!

● **GOLDBLATT SHOVELS**—Blade, shank and socket of these fine shovels are forged from one solid bar of steel, double-tapered with a heavy center to give you maximum strength at the point of greatest need. X-Grade, Northern Ash handles with a Burntcote finish make these shovels tops in the trowel trades. All have turned steps.

9¾" x 11¾" Square Point Shovel with 27" D Handle
09 423 E7...\$7.50

ALUMINUM SCOOP

9¾" x 11¾" Square Point Shovel with 47" straight handle
09 424 E7...\$7.30
8¾" x 11½" Round Point Shovel with 27" D Handle
09 425 E7...\$7.50
8¾" x 11½" Round Point Shovel with 47" straight handle
09 430 E7...\$7.30

● **GOLDBLATT ALUMINUM SCOOP**—Lightweight tempered aluminum alloy blade with natural finish. The lightest and best for shoveling sand and other loose materials. Burntcote finished ash 27" handle, 15¾"x20" blade 09 446 H7...\$12.10

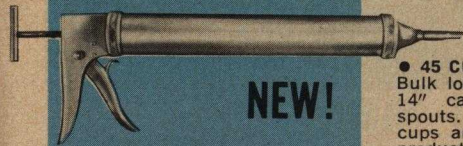

NEW!

CAULKING

● **45 CU. IN. PRODUCTION GUN**—Bulk loads or takes 8½", 10" and 14" cartridges with or without spouts. Two heavy duty plunger cups and one #8 nozzle for real production. Coarse thread end cap takes only two turns to put on. With 45 cu. in. capacity you work longer, reload less often. All-steel, long lasting Zinc-plated construction, strong but light with grip and trigger that fit your hand comfortably. Threaded cylinder for easy cleaning; stop flow with a twist of the handle.

07 265 H7....\$12.10

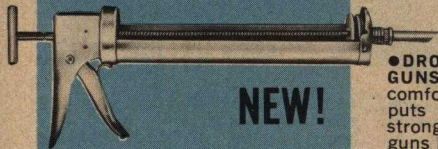

NEW!

GUNS

● **DROP-IN CARTRIDGE CAULKING GUNS**—An easy squeeze of the comfortable trigger and hand grip puts you in business. Light but strong, these all-steel, zinc-plated guns have instant pressure release; just twist the handle to stop material flow. A special front-end cap prevents leaks. Takes both "hole in cap" and spouted cartridges. The threaded adaptor fits standard male nozzles.

Quart Gun 07 116 H7....\$11.50
Same as above but has no threaded adaptor nozzle. Takes spouted Cartridges only.
Cartridge Gun07 117 H7....\$9.50

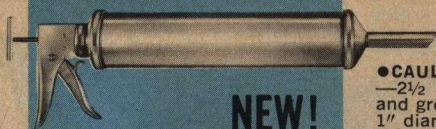

NEW!

● **CAULKING AND GROUTING GUN**—2½ quart capacity for caulking and grouting. Comes complete with 1" diameter nozzle plus adaptor to take smaller female threaded nozzles. Bulk load with grouting or caulking compound, mortar, asphalt, cement or drywall adhesives. All-steel, rust resistant construction. 3½"x16" Ideal for grouting hollow door bucks and metal bases

07 114 H7....\$54.50



NEW



BUCKETS

● **FORTEX RUBBER PAILS**—These reinforced molded rubber pails won't rust, dent, leak or chip. They resist heat and cold, acids, alkalis, and most other chemicals. Heavy duty flange with reinforced galvanized fittings insures long life.

10 qt. heavy duty pail
09 460 H7....\$3.10
14 qt. heavy duty pail
09 461 H7....\$5.35
12 qt. heavy duty pail with pouring lip09 462 H7....\$5.35
12 qt. utility pail with pouring lip
09 463 H7....\$3.75
18 qt. utility pail with pouring lip
09 464 H7....\$5.20



NEW!

● **FLEXIBLE GROUT BUCKET**—This rugged flexible polyethylene pail is seamless, rustproof, non-corrosive and dent-proof! Pail resists acid attack, withstands temperatures as low as -30° F! 11" wide x 11" deep. Holds 14 quarts.

12 195 H7....\$1.98

● **FORTEX RUBBER TUBS**—Mix small mortar batches, dip bricks and tile for wet setting or use for dozens of other jobs. The same sturdy, reinforced rubber construction as the pails above.

6½ gal. tub09 465 H7....\$4.75
3 gal. tub09 466 H7....\$2.75



NEW!

Put your work on wheels; Adjusts from 16' to 6' 3"

ROLLING SCAFFOLD

● **WACO SPEEDTOWER**—A rolling scaffold makes slow jobs go fast. Work on a roomy, 28"x75", steel-framed plywood deck that adjusts from 16" to 6' 3" without tools. A flick of your toe unlocks the 5" rubber-tired steel wheels; you roll instantly to your next location; another flick of your toe locks the wheels bed-rock-solid. Only 28½" wide, it moves through doors easily; sets up on stairs; knock it

down to a flat 2' 5" x 7' 2" x 6" package to carry it to your next job. Double forged screw locks at each corner keep your Speedtower rigid, make it easy to set up or knock down. 15" spacing on "ladder rung" ends make it easy to climb on board. A necessity for today's fast-moving building and maintenance crews. F.O.B. Cleveland, Ohio 07 789 E3....\$109.95

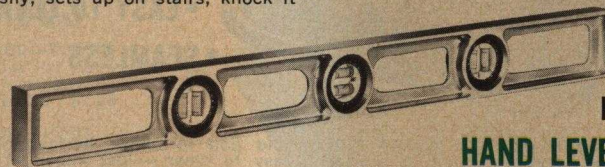

NEW HAND LEVELS

● **GOLDBLATT UTILITY LEVELS**—Cast aluminum levels precision milled flat to give you great accuracy and reliability. Each has six easy reading vials. So light you

hardly know you have one in your hand. A necessity in your tool box.

24" level09 457 H7....\$6.55

28" level09 458 H7....\$7.75

30" level09 459 H7....\$8.90

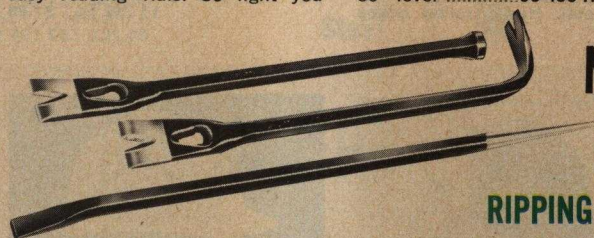

NEW!

RIPPING BARS

● **RIPPING, LINING & ANGLE BARS**—Rugged, heavy duty forged steel pry bars made to take it for years. The 18" Ripping bar has a target head for hammering; the 24" lining bar is pointed at one end, has a

chisel blade at the other; the 18" angle bar has three nail pullers built into the blades.

18" Ripping Bar.....09 447 H7....\$2.20

24" Lining Bar.....09 448 H7....\$3.90

18" Angle Bar.....09 449 H7....\$2.65

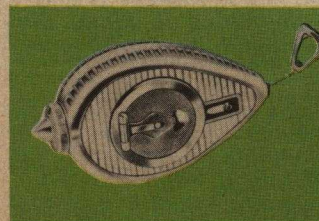

● **DUAL PURPOSE SELF-CHALKING LINE BOX**—Combination Chalk Line and Plumb Line. Plumb Bob Tip is refill cap. Twist of the fingers, it's open for quick refill. Another twist, it's locked. Complete with 100' line.

09 301 H7....\$2.00

CHALK—Use in above box. Has 3 to 5 times the strength of regular chalk. Won't cake. Dark Blue.

8 oz. can09 304 H7.... .55

8 oz. can Red:.....09 306 H7.... .55

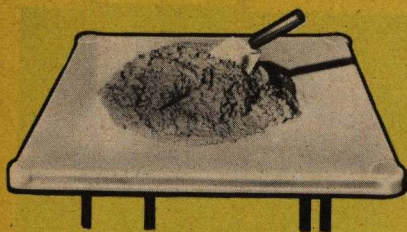

FIBERGLASS MORTAR BOARD

● **MASON'S FIBERGLAS MORTAR BOARD**—Light, but tremendously strong, this new Fiberglas mortar board is 30" x 30" with a 1¼" lip for extra strength. Can't absorb water from mortar. Masons no longer need temper mortar again and again. Lip is reinforced with

wire for rigidity. Fiberglas wears and wears—trowel edges won't splinter it. Won't warp. Cleans easy.

One only.....11 584 E2...\$ 7.40

1 Carton of 8.....11 884 E2... 58.00

POLYETHYLENE



● **POLYETHYLENE MORTAR BOARD**—This lightweight, low cost, 30" x 30" polyethylene mortar board won't absorb water, won't splinter. Dry mortar won't stick to its surface—to clean, just flex it slightly. Because it sucks no water from your mud, you don't need to temper mortar. Your trowel won't pick up wood splinters with the mortar.

11 580 E4...\$7.25

PLASTIC MORTAR BOARD PAN



- **LIGHTWEIGHT**
- **RUST PROOF**
- **DENT PROOF**
- **EASY TO CLEAN**
- **SEAMLESS**

● **PLASTIC MORTAR BOARD PAN**—Here is a revolution in mortar board pans—this lightweight, high density plastic pan makes all others old fashioned. Absolutely unaffected by plaster, mortar or water. Lightweight (less than 5 lbs.), seamless and sturdy, it outwears metal. Heavy rolled edges

hold pan in shape permanently. Easy to clean—just knock dried mortar out of the pan with a few hammer blows on the bottom. Dimensions: 30" x 30" at top, tapering to 16" x 16" at bottom; 7" deep. **GUARANTEED TO SATISFY OR YOUR MONEY BACK.**

11 292 E4...\$7.85



● **SAFETY CAPS AND HATS**—A double set of crossed nylon webbing slows down, then stops any blow to make these hats the safest ever. A new way to hold hatshell to headband gives you improved protection against side blows.

Each hat adjusts three ways: In size from 6½ to 8½; for low, medium or high head profiles; the headband adjusts inside the shell to keep the right space between head and hat. There are no inner projections.

The Plastic hats exceed all Federal Specifications including electrical resistance. Aluminum and



Fiber Glass models exceed all specs but electrical resistance.

PLASTIC—Standard color: Yellow; any color on orders for 25 or more.

Plastic Cap09 417 H5...\$4.95

Plastic Hat09 416 H5...\$4.95

FIBER GLASS—Standard color: White; any color on orders for 25 or more.

Fiber Glass Cap....09 407 H5...\$4.35

Fiber Glass Hat....09 406 H5...\$4.35

ALUMINUM—Standard color: Gold anodized; any color on orders for 25 or more.

Aluminum Cap....09 418 H5...\$4.85

Aluminum Hat....09 419 H5...\$4.85

MORTAR BOXES

LEAK-PROOF STEEL

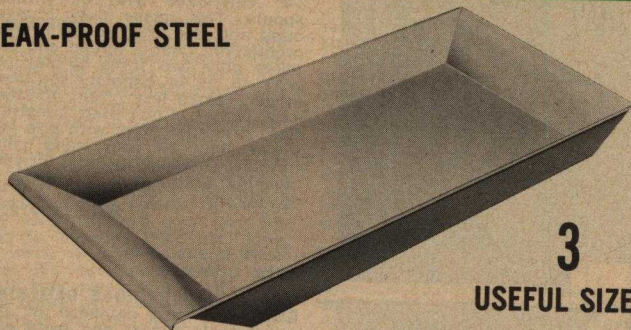

3

USEFUL SIZES

● **STEEL MORTAR BOXES**—Leak-proof, perfectly smooth interiors make mixing or cleaning easy. All joints electrically welded. Won't warp, shrink, or open up. Place over a fire to heat mortar or cement in cold weather. Made of heavy gauge rust-resistant, cold rolled steel. Outside edges are rolled to an angle to reinforce and strengthen box, make handling easy.

15 CU. FT. MORTAR BOX—14 gauge steel. 82" long, 34" wide, 11" deep. 114 lbs. 07 205 E5...\$39.95

9.2 CU. FT. MORTAR BOX—16 gauge steel. 64" long, 28" wide, 11" deep. 62 lbs. 07 206 E5...\$28.45

6 CU. FT. MORTAR BOX—16 gauge steel. 53" long, 25" wide, 11" deep. 49 lbs. 07 210 E5...\$23.45

BARROW



● **BRICK & TILE BARROW**—Carries up to 120 bricks. Made of rugged, seasoned hardwood for long service. The ribbed dash is adjustable. Steel wheel guard adds rigidity to this heavy-duty barrow; wide-spread legs make it tip-proof, even fully loaded. 2-ply pneumatic tire. Bearings are self-lubricating. Weight, about 72 lbs. F.O.B. Kansas City or Harrisburg, Pa.

11 570 E2...\$31.95

\$31.95



● **MORTAR HOE**—Two hole, 5½' handle, 10" Blade

07 228 H7...\$7.90

FOLDING STAND

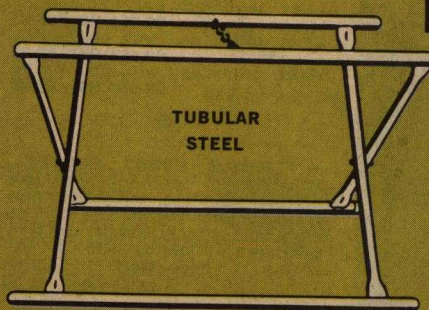

TUBULAR
STEEL

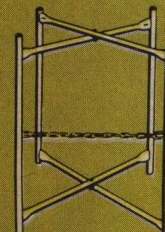

● **TUBULAR STEEL FOLDING MORTAR BOARD STAND**—You'll like this tubular steel frame-stand for use on the scaffold, because it's sturdy, light and easy to handle. Outlasts ten wooden stands.

Only 21" high used on its side. Stand it on end for a floor stand 30" high to replace two box stands. Weighs under 18 lbs.

11 291 E4...\$11.25

MULLER Rubber Blade MIXERS



5 1/2 CUBIC FOOT

● **5 1/2 CU. FT. MIXER.** Specifications. Width 29". Length 60 1/2". **PADDLE SHAFT**—1 3/8" Diameter. Sealmaster self-aligning bearings. Everlasting Shaft Seals. **MIXING PADDLES**—Heavy Steel bars with adjustable blades; rubber scraper blades for better mixing action on all machines listed below. **DRIVE**—Double V Belts to Machine Cut Gears with Power Throatout. **FRAME**—of Heavy Steel Channel. **WHEELS**—Disc-Type with Roller Bearings and 4" x 8" x 16" Pneumatic Tires. Mixers "FOB NJ" are FOB Metuchen, New Jersey; Mixers FOB K.C., are F.O.B. Kansas City.

With **110 Volts, 1 Phase, 1 1/2 hp Electric Motor, rubber mixing blades.** Weight **460 lbs.**

F.O.B., K.C., **07 507 E2. \$549.00**
F.O.B., N.J. **07 308 E2. \$520.00**
(220-440 volts, 3 phase Motors at no extra cost).

With **4.5 hp Briggs & Stratton Engine, rubber mixing blades.** Weight **480 lbs.**

F.O.B., K.C., **07 502 E2. \$519.00**
F.O.B., N.J. **07 303 E2. \$490.00**

With **6 hp Wisconsin Engine; rubber mixing blades.** Weight **480 lbs.**

F.O.B., K.C., **07 508 E2. \$590.00**
F.O.B., N.J. **07 305 E2. \$550.00**

STANDARD MULLER MIXERS—All models have a deep, extra capacity mixing drum made of heavy gauge Mayari "R" steel. The new grid with built in bag splitter is heavier gauge steel, made to swing away when you discharge the mixer. A heavy duty power throw-out stops the paddles of the 5 1/2 ft. machines without stopping the engine. All models have lifetime sealed trunnion bearings.

Paddle shaft seals are guaranteed for the life of the mixer. These rugged mixers give you thoroughly mixed mortar every time—plus reliability.

GUARANTEE: All mixers guaranteed. Paddle Seal Unconditionally Guaranteed for the life of the mixer, when properly lubricated.



3 1/2 CUBIC FOOT

ONLY \$305.00

● **3 1/2 CUBIC FOOT MIXERS**—With 2.8 hp B. & S. engine; straight drive; rubber mixing blades for longer life and better mixing action. 10" x 2.75" solid rubber tires. Weight 200 lbs. net. Mixers "FOB NJ" are FOB Metuchen, New Jersey; Mixers FOB K.C., are F.O.B. Kansas City.

3 1/2 CUBIC FOOT MIXERS—With 2.8 hp B. & S. engine; straight

Drive, 10" x 2.75" solid rubber tires. Weight, 200 lbs. All Mixers come with rubber scraping blades.

F.O.B., K.C., **07 334 E2. \$337.00**
F.O.B., N.J. **07 325 E2. \$325.00**

With 3/4 hp electric motor, 110 volts, 1 phase, 10" x 2.75" solid rubber tires, rubber mixing blades. Weight 200 lbs.

F.O.B., K.C., **07 336 E2. \$367.00**
F.O.B., N.J. **07 327 E2. \$355.00**

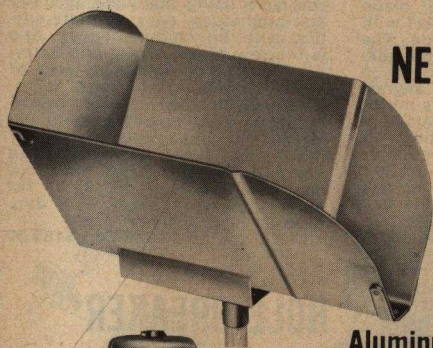

Aluminum

NEW!

MORTAR HODS

● **STEEL MORTAR HOD**—Sturdily constructed. Weight 10 3/4 lbs. complete with 3 1/2" wood handle. **11 288 E5...\$7.85**

● **ALUMINUM MORTAR HODS**—Lightweight. Ease the load on your shoulder when carrying a full hod up a ladder. Safer because they're lighter, better balanced than steel. Heliarc welded with riveted reinforcing at lip. Complete with handle. 24" x 14" x 12" hod...weighs 6 3/4 lbs. **11 890 E5...\$19.50**
24" x 16" x 14" hod...weighs 8 lbs. **11 891 E5...\$21.00**

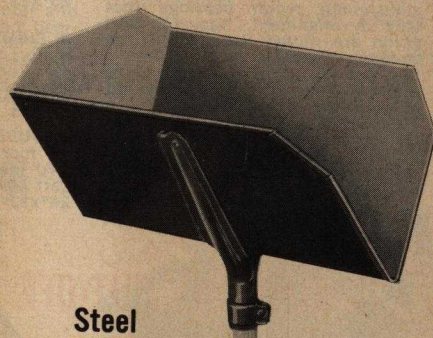

Steel

MUD MIXERS

● **THIN COAT & DRYWALL MUD MIXERS**—These rugged, heavy duty mixers are ideal to mix thin coat and heavy taping cements because they have the extra power, the rugged construction and three perfectly balanced impellers required to thoroughly blend these mixes very quickly. Shipped right in their own drums, these mixers are ready to use when they arrive on your job. Both have 1725 rpm, 3/4 hp capacitor electric motors operating at 6 to 1 ratio to give you a 290 rpm impeller speed.

16 Gallon Mixer, (F.O.B. Port Clinton) **13 767 E3...\$199.50**
30 Gallon Mixer, (F.O.B. Port Clinton) **13 768 E3...\$219.50**

LIME MIXERS

● One-bag and three-bag models. Just pour in water and lime; then hit the switch. In a few minutes you have the smoothest, easiest spreading finish coat you ever worked. The One-bagger turns out enough lime putty to keep up to 20 men busy. The three-bagger is great for spray-on plasters. They clean in seconds; fit in your car trunk. Both models have weather-proof top, Westinghouse heavy-duty motor, sealed waterproof gear box, and **GUARANTEED BY GOLD-BLATT.**

ONE-BAG QUIKSTIR (F.O.B. Port Clinton) **13 700 E3...\$149.50**
THREE-BAG QUICKSTIR (F.O.B. Port Clinton) **13 702 E3. \$169.50**



NOW! GOLDBLATT'S OWN TILE SAWS



NEW!

AS
LOW
AS
\$139.00



NEW!

● **GOLDBLATT TILE SAWS**—Here are tub saws that do more than any others—yet cost less. First, there's the "wide open" cutting area. There are no supports to block your tile while you're cutting so you can make fast smooth cuts that are impossible on other tile saws. The tub is out of the way too. Flip-top blade guard makes blade changing a pleasure, not a chore. Just change blades and go back to work.

The cast aluminum table runs on silk-smooth nylon bearings that stay in alignment. Backstop and guide are milled flat for extreme accuracy. Cast-in water channels take the full volume of an oversize pump and return it to the tub out of your way.

These are precision machines throughout—built to perform like a brick saw. Every bearing is sealed, self-lubricating and needs no maintenance. But, if you ever do replace a bearing, you'll do it in minutes without special tools.

And examine our prices. Model for model, machine for machine, you can't buy a tile saw as good as Goldblatt's anyplace else.

All Goldblatt Tile Saws are guaranteed: Satisfaction or your Money Back. Order one of these tile saws now.

Blade not included in prices below

● **THRIFTILE SAW**—Specs. 1/3 hp motor; takes 6" blade, makes 13/4" max. depth cut; 5/8" arbor; max. cart travel 12"; Dimension overall, 25"x22"x21 1/2" high.

12 229 E4...\$139.00

● **EIGHT INCH SAW**—Specs. 1/2 hp motor; takes 8" blade, makes 23/4" max depth cut; 5/8" arbor; max cart travel 12"; Dimension over all, 26"x22"x22 1/2".

12 233 E4...\$159.00

● **SUPER EIGHT SAW**—Specs: 3/4 hp motor; takes 8" blade; makes 23/4" max depth cut; 5/8" arbor; max cart travel 12"; Dimension overall, 26"x22"x24 1/2" high.

12 234 E4...\$179.00

● **GOLDBLATT TRAY SAW**—Ever try to make a 45° cut along the diagonal of a 12" tile with a tub saw? You can't do it easily. Now here's the answer to sawing these increasingly popular tiles in a minute without fuss. We built this tile saw to be the most versatile portable saw you can find. With 21" of travel, you can saw from one corner of a 12" tile to the other in one easy motion. And this saw has power to spare. The 3/4 hp motor will turn either an 8" or 10" blade—makes cuts as deep as 33/4" with the recommended 10" blade. The precision built cart runs on silk-smooth nylon bearings riding on steel rails for perfectly aligned cuts. The back of the cart is milled flat so a tile bucks against it solidly making your cutting job easier. To make sure your cuts are square, we mill the backstop and guide to close tolerances so you can make the most accurate cuts you've ever sawed.

The flip-top blade guard makes

blade changes a matter of a minute—just flip up the guard and change your blade. You're back at work in less time than it takes to remove the guard on old-fashioned machines.

This is a completely new machine specifically designed for the tile-setter of the 1960's. Think about how much tile setting technology has changed in the last 12 years, then ask yourself why you're using a saw that is the same as the one you were using that long ago. For fast production, easy accurate cutting with no chipped edges, this is the saw to use. Order one today. It's Guaranteed to satisfy you or your money back.

Blade not included in prices below
Goldblatt Tray Saw Specs: 3/4 hp motor; standard machine takes 10" blade, available with 8" blade guard on special order; max cut depth with 10" blade, 33/4"; 5/8" arbor; max cart travel, 21"; dim. overall, 20"x31"x17 1/2" high.

12 235 E4...\$189.00



DIAMOND CUT-OFF BLADES

● **COST CUTTER DIAMOND BLADES**—Diamonds embedded in the edges of these blades give you continuous action at both sides and rim for smooth, clip-free cut. Use wet only. Order by number. Specify material you intend to cut.

6" Cost Cutter 12 613 E3...\$18.75
8" Cost Cutter 12 614 E3...\$26.75
10" Cost Cutter 12 615 E3...\$38.75

● **INTERLOK DIAMOND BLADES**—Made in segments like a brick saw blade to give you faster cutting, longer blade life, smoother cuts. Segments allow water to get deeper in the cut to cool blade and improve cutting action. For real tile saw production, use these blades. Will cut concrete, marble, masonry, slate, concrete as well as tile.

Use Wet Only!
Order by number and specify material you intend to cut.

6" Interlok11 540 E3...\$25.00
8" Interlok11 542 E3...\$34.00
10" Interlok11 544 E3...\$46.00
12" Interlok11 547 E3...\$59.00



● **KIMBERLEY DIAMOND CUT-OFF BLADES**—These blades make an exceptionally smooth cut, free from grabbing and with no chipping of glazed tile surfaces. The greater rigidity of these blades eliminates wheel wobble. Best low cost, metal-bonded diamond blade yet developed for tile and ceramic industry. These wheels are carried in stock. Body thickness, .055". Standard 5/8" arbor hole.

6" Diamond Blade
12 236 E2...\$18.90
8" Diamond Blade
12 238 E2... 26.70

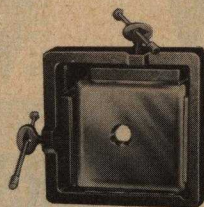

HOLE BREAKER

● **HOLE BREAKER**—Fast, Practical, Economical. Just tighten thumbscrews of this one-piece metal frame and give a solid tap with hammer to start. A series of rapid taps make the hole.

4 1/4" x 4 1/4".....12 230 E2...\$8.95

CARBIDE ROD SAW

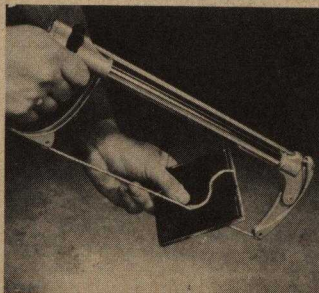

● **TUNGSTEN CARBIDE ROD SAW**—Fitted to your own hacksaw frame you cut fancy designs or straight through tile, marble, glass, granite, brick or almost anything with this brand new saw blade. Flakes of tungsten carbide, the hardest man-made material next to diamonds, easily cut through the hardest ceramic and metal materials. So new and so versatile we don't yet know all the things it will do. Blade is 12" long with mounting eye at each end. One 12" T.C. Blade

02 410 H5...\$ 2.00
Pkg. of 10 12" T.C. Blades
02 411 H5...\$18.00

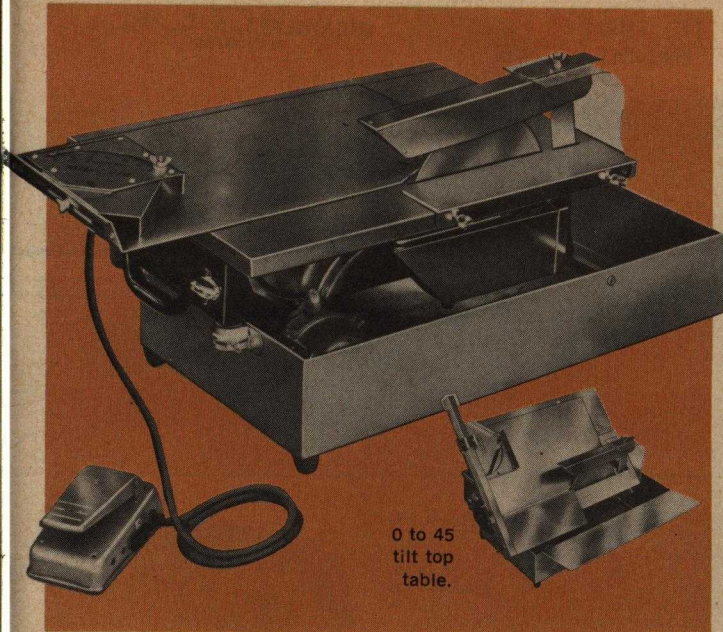

0 to 45
tilt top
table.

● **BUZZMASTER TILE SAW**—Truly portable—44 lbs. This rugged, one hp table saw makes more kinds of cuts than any other. No need to carry extra tools. This one cuts holes, slots, rounded corners, miters, bevels and scores all types of field and trims. Enough power to cut several tiles at once, stacked up to 2". Accurately tracking table has take-up adjustment for wear. Sealed Ball Bearing Spindle. Submersible pump with fine filter.

Use steel, carbide or carborundum blades from 4" to 7" and accessories, to cut wood, vinyl, asbestos compositions, plastics, metals, acoustical panels, etc. The coolant system detaches in seconds. 22" x 12" Coolant Tray has fast-drain hose. 6-Jet coolant supply extends blade life.

INCLUDES: 7" diamond blade for economical, dustless cutting of all ceramics, slate, marble, quarry, up to 2" thick; Socket wrench for quick blade change; 1/2" blade arbor; 4800 rpm, 115V, geared 1 HP motor uses no belts. Foot Control leaves both hands free. All angle Miter-Jig Accessory.

Table Size: 13 7/16" x 19 1/4"; Overall: 14" x 24" x 9"; Fully assembled, ready to run; 13' 3-wire cord with plug adaptor, full instructions.
12 242 E3....\$200.00

● **7" GENERAL PURPOSE RIMLESS** diamond blade with Buzz-Master hub. 12 243 E2....\$19.75



\$185

IMPROVED
SUBMERSIBLE
PUMP

● **PORTABLE TILE SAW**—Scores and saws all types of tile; makes perfect angles, square cuts, accurate miters and uniform segments for edging circles.

Comes with 1/2 hp, G.E. motor, all accessories; nothing else to buy. Easy-to-reach on-off switch at back of machine. Motor, spindle, tubular steel frame and tracks bolt into one compact, easy-to-carry unit to hook over tub instantly. Lightweight aluminum table rides rust-proof brass rollers. It is smooth and grab-free. The sealed ball bearing quill keeps water and grit out of the spindle and bearings. The submerged coolant pump floods the blade at all times with cooling water that starts from the hub and floods outward to flush cut and blade. This adds 25% to

blade life, removes excessive sludge, ends scorched blades and tile. Belt is fully guarded.

SPECIFICATIONS: 1/2 hp, G.E. motor; 8" Kimberley diamond blade; 90° protractor; 45° miter jig; rip fence. Table, 8 1/2" x 15"; max. table travel, 12 1/2"; cut depth with 6" blade, 1 1/2"; with 8" blade, 2 1/2"; Arbor diam., 5/8"; max. height with tub, 22 1/2". Galvanized steel 24" x 24" tub.

F.O.B., Kansas City.
12 610 E2....\$190.00

F.O.B., Torrance, Calif.
12 611 E2.... 185.00

With 3/4 hp Motor
F.O.B. Torrance, Calif.
12 612 E2....\$205.00

TILE CUTTING MACHINES

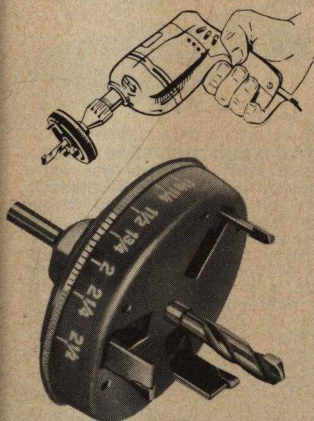

● **ADJUSTABLE HOLE SAW—CARBIDE TIPPED**—This brand new carbide tipped hole cutter fits in any 1/4" electric drill or drill press chuck. Adjusts instantly by rotating knurled ring. Cuts holes any diameter from 1 1/8" to 2 1/2" in seconds. No chipping. No hammer, no vise needed. Perfect holes every time. Will save you time every day. All metal construction. Rugged. Cleverly designed. The hottest new tile tool we've seen in years12 208 H7....\$16.75

● **REPLACEMENT CARBIDE TIPS FOR TILE HOLE**—Set of three replacement tips for above hole saw.
12 209 H7....\$7.98

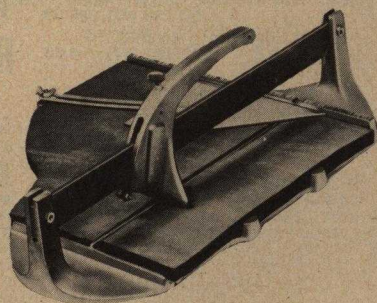

● **16" TILE CUTTER**—With Mon-mouth and other large tiles becoming more and more popular, you'll use this new, larger tile cutter on more jobs all the time. This cutter scores tile up to 16" wide, 1 1/2" thick. The working table extends 10" to the right of the breaker bar, 4" on the left, it comes with a carbide cutting wheel for long life. Overall size is 16" x 21 1/2", weight is 15 lbs. With only one moving part, you can expect (and get) long life from this tool. Made of cast aluminum alloy. 12 210 H7...\$31.00

● **CARBIDE CUTTING WHEEL**—The hardest man-made metal—nearly hard as diamonds. Lasts many times the life of ordinary wheels. Economical, no changeovers; fast. 12 221 M7....\$3.75

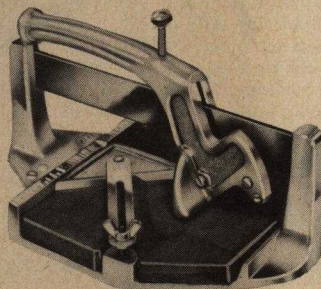

● **MIDGET TILE CUTTING MACHINE**—Complete with a three-wheel turret. Cuts tile up to 6" wide. Overall size 6 1/2" x 11". Weight 4 1/2 lbs. 12 200 H7....\$11.00
Spare Pair Pads..12 215 H7.... .79

● **HARDENED STEEL WHEEL TURRET**—Six tempered steel wheels per turret. Cut fast and economically. Two turrets per pkg. 12 226 H7....\$1.80

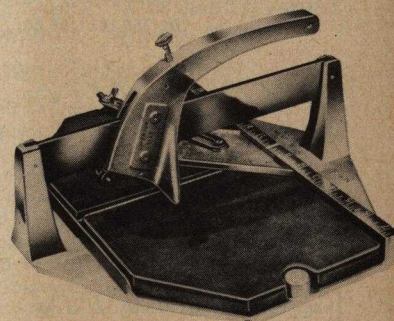

● **STANDARD TILE CUTTER**—12x12" board with adjustable handle. Working table is 6" wide on each side of breaking ridge. Comes with 6-wheel turret.
12 202 H7....\$13.85
Spare Pair Pads..12 216 H7....\$ 1.10

● **LARGE TILE CUTTER**—Cuts a 10" ceramic tile, ceramix flex tile or cuts a 9" tile on the diagonal. Comes with 6-wheel turret.
12 204 H7....\$15.85
Spare Pair Pads..12 217 H7....\$ 1.60

● **TILE CUTTERS**—Score and break wall tile, bull nose, shoe base, thin vitreous and quarry tile in one fast operation without moving the tile. Each machine scores and breaks a tile up to 7/8" thick. Illustrated directions included.

NOTCHED TILE MASTIC TROWELS

STAINLESS STEEL
POWER PINS

NO TURN
HANDLE

NO TURN
GOLDBLATT, K. C., MO.
ROCK-RIB®



GUARANTEE

Regardless of time limitation, we absolutely Guarantee Rock-Rib® Trowels against loosening of blades—against weakening or distortion of ribs—while these tools are safeguarded from deliberate abuse!

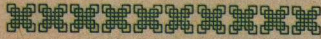

● **ROCK RIB NOTCHED TROWELS**—All trowels 10½" x 4½". Made with forged aluminum mountings locked to fine trowel steel blades with Power Pins; they do the work of rivets, but do not weaken the mounting. Fitted with fine natural wood handle. Guaranteed against loosening of blades, weakening or distortion of ribs during normal use.

YOUR CHOICE OF FOUR NOTCHED SHAPES and SIZES



Notches ⅜" deep on ⅝" centers.

● **V-NOTCH TROWEL**—Spreads both floor and wall mastics. Notches ⅜" deep on ⅝" centers.
02 356 M7...\$5.50



Notches ⅜" deep on ⅝" centers.

● **LITTLE U TROWEL**—Recommended by Minnesota Mining Co. for their CTA-12 mastic. Notches ⅜" deep on ⅝" centers.
02 355 M7...\$5.50



Notches ⅜" deep on ⅝" centers.

● **FOR PLASTIC FLOORING**—This is the notching recommended by Torginol of America, Inc. for application of their flooring material. Notches ⅜" x ⅜" deep on ⅝" centers
02 353 M7...\$5.50

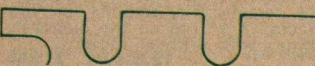

Notches ⅜" x ⅜" on ⅝" centers.

● **BIG U TROWEL**—Recommended by Minnesota Mining & Manufacturing Co. for use with their CTA-11. We recommend it for general mastic work. Notches ⅜" x ⅜" on ⅝" centers.
02 357 M7...\$5.50

NIPPERS

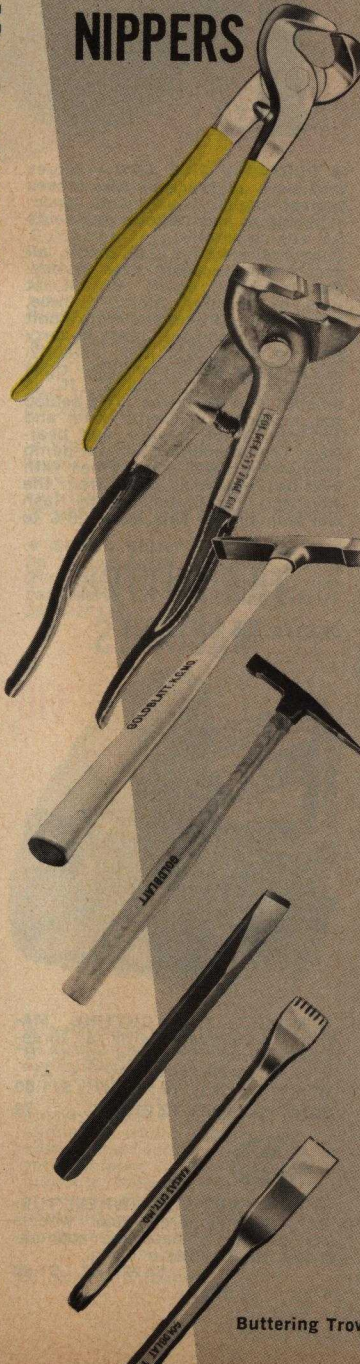

● **WIDE BIT TILE NIPPER—PLASTIC DIPPED HANDLES**—This fine forged, nickel chrome plated 8" nipper has ⅝" wide offset jaws. Handles are plastic dipped for comfortable use. Handle stops prevent jaws from biting together. Carbide Tipped (illus.)
02 404 H7...\$7.20

Plain Steel (not illus.)
02 405 H7... 3.30

● **NARROW BIT TILE NIPPERS**—This forged tool steel 8" nipper with ½" offset jaws is carefully hardened. A return spring opens the jaws; handle stops prevent teeth from biting together. Carbide tipped (illus.)
02 408 H7...\$6.60

Tool Steel 02 407 H7... 3.00

● **CARBIDE TIPPED HAMMER**—Here's a unique hammer that's tungsten carbide tipped. This handy, perfectly balanced little hammer weighs 4 oz.

Head and Cutting Edge Tipped
02 190 H7...\$5.50

Cutting Edge Only Tipped
02 192 H7... 4.00

● **FINE TILE HAMMER**—A very delicately forged hammer for fine tile and marble work. Adze Eye. Wt. 3½ oz.
02 181 H7...\$2.80

● **MARBLE-TILE HAMMER**—A forged hammer preferred for interior tile and marble work. Adze Eye Construction. 9 oz. Not shown.
02 182 H7...\$3.15

All Goldblatt Tile Chisels are forged from hexagonal shanks from carefully heat-treated tool steel.

● **CARBIDE TIPPED CHISELS**—Hexagonal 6" shanks, tipped with tungsten carbide. Top quality.

¼" Carbide 02 176 H7...\$1.60
⅜" Carbide 02 177 H7...\$1.75
½" Carbide 02 178 H7...\$2.40

● **TOOTHED CHISELS FOR TILE & STONE**—Hexagonal 8" shanks with hardened, cleanly cut teeth.

¼" Toothed 02 156 H7...\$1.25
⅜" Toothed 02 157 H7...\$1.25
⅝" Toothed 02 158 H7...\$1.25
½" Toothed 02 159 H7...\$1.25

● **PLAIN CHISELS FOR TILE & STONE**—Hexagonal 8" shanks, natural bits.

¼" Plain 02 126 H7...\$1.05
⅜" Plain 02 127 H7...\$1.05
⅝" Plain 02 128 H7...\$1.05
½" Plain 02 129 H7...\$1.05



● **TILE SETTER'S RUB BRICKS**—Top quality 6" x 2" x 1" carbide rub bricks for dressing and smoothing tile, marble, granite, and concrete. Low numbers are the higher coarse, high numbers finer grit.

24 Grit 02 102 H7 \$1.35
30 Grit 02 103 H7 \$1.35
46 Grit 02 104 H7 \$1.35
60 Grit 02 105 H7 \$1.35
80 Grit 02 106 H7 \$1.35
120 Grit 02 107 H7 \$1.35
150 Grit 02 108 H7 \$1.35

TILE COUNTER TAPE RULE



● **TILE COUNTING TAPE RULE**—This 8' steel tape rule has extra scales on the back of the blade to make tile estimating and layout easy. One edge of the ½" wide rule counts up to twenty-four tiles, the other edge counts up to eleven 9" x 9" floor tiles. The face of the blade is marked in standard feet and inch markings with stud marks every 16". One edge of the face of the blade is marked to 32nds for the first foot. 02 200 H7...\$2.20



VINYL KNIFE

● **HEAVY DUTY VINYL KNIFE**—Extra heavy point. So rugged, so sharp it cuts hard core vinyl without heat. And, of course, cuts all other soft materials too. Fine high carbon steel, individually hardened, tempered, sharpened and honed. Make accurate, even cuts easily, without burrs.

02 300 H8...\$1.60

FOR
OTHER
TROWEL
SIZES SEE
PAGES
2 and 3

STAINLESS STEEL
POWER PINS NO TURN
HANDLE



MIDGET TROWEL



● **MIDGET TROWEL** — Great for window sills, closets, small areas. Carry one in your tool bag for these jobs. 7½" x 3". Camel Back Only03 407 M7 \$5.00

PIPE TROWEL



● **IMPROVED PIPE TROWEL**—Plaster hard-to-get-at places in half the time, with half the effort. The offset handle lets you slip the trowel between pipes; the long nose makes it easy to get it behind fixtures. 3"x10½"....03 501 M7 \$5.60

POOL TROWELS



● **ROUND END POOL TROWELS**—Made of flexible stainless steel, you can bend these short-shanked trowels to the radius you need for almost any pool. Stainless steel stands up under rough treatment with gunned mixes. Shanks are lightweight but tremendously strong forged aluminum. Camel back handles. Trowels have completely rounded ends to prevent digging into curved slab and pool sides.

12" x 3½" 06 176 M7...\$5.90
14" x 4" 06 177 M7...\$6.30

NOTE
SHORT
SHANK

PLASTERING TROWELS

THE
AIR-LIGHTTM

IS LIGHTER
AND
STRONGER

EACH
TROWEL IS
PRECISION
BALANCED
AND
BROKEN-IN
WON'T
WEAR
OUT
YOUR
ARM

SIZE	FOR CAMEL BACK HANDLE ORDER No.	FOR STRAIGHT HANDLE ORDER No.	PRICE
10½" x 4½"	03 455 M7	03 425 M7	\$5.40
11" x 4½"	03 451 M7	03 421 M7	\$5.40
11" x 4¾"	03 447 M7	03 417 M7	\$5.40
11½" x 4"	03 446 M7	03 410 M7	\$5.40
11½" x 4½"	03 456 M7	03 426 M7	\$5.40
11½" x 4¾"	03 448 M7	03 418 M7	\$5.40
12" x 5"	03 468 M7	03 438 M7	\$5.55
HANDLE ONLY	03 408 M7 80c	03 409 M7 55¢	

NO RIVETS - POWER-PINS* Are Stronger Than Rivets!
BLADE - Finest, Flexible Trowel Steel Money Can Buy!
MOUNTING - Strongest Aluminum Forging Made!
HANDLE - Comfortable, Lightweight Bass Wood!

Here is the plastering trowel you need! So light, so easy on your arm that you'll never own any other trowel once you have an AIR-LIGHT in your tool kit. Only Goldblatt gives you the light aluminum mounting precisely forged to a teardrop shape for great strength with very little weight; only Goldblatt gives you the best steel blade money can buy, mirror finished and broken in on a special machine; and only Goldblatt gives you stainless steel Power PinsTM to replace old-fashioned rivets to lock blade and mounting together—no rivet holes in the rib weaken your trowel! The result: the unconditionally guaranteed AIR-LIGHT plastering trowel. No other trowel you can buy is guaranteed; no other trowel is as light, straight, strong and true as AIR-LIGHT. Buy one. You'll feel the difference when you heft it—on the job, you'll prove it. Money back guarantee.

**THE ONLY TROWEL IN THE WORLD
WITH AN UNCONDITIONAL
GUARANTEE**

Regardless of time limitation, we absolutely Guarantee AIR-LIGHT Trowels against loosening of blades — against weakening or distortion of ribs — while these tools are safeguarded from deliberate abuse or mis-handling!

PLASTERER'S FLOATS



MOLDED RUBBER

● **MOLDED SPONGE RUBBER FLOAT**—This is our most popular sponge float—and it is made by no one else. The sponge rubber in this float is molded very compactly, with a dense texture. The shaped, molded rubber float face is then permanently cemented to a specially shaped back plate.

The texture of this float is as even and fine as any you will ever get anywhere. The float is fitted with our finest natural wood handle; the most comfortable to use handle yet devised. Float is 8" x 4".
Molded Float.....03 295 M7...\$2.20
Molded Sponge Pad—Fits this tool only. 8" x 4".....03 297 M7...\$1.00



FOAM PLASTIC

● **FOAM PLASTIC TEXTURE FLOAT**—A long wearing texture float of a special formula foam plastic. Costs less than sponge, does an excellent job of bringing the sand to the surface. Easy to use. Most journeymen feel it does the job faster than a regular rubber sponge float. Gives a medium texture. Will give the best texture float service you ever had.
10" x 4" x 3/8"

03 502 M7...\$1.80

● **JUMBO FLOAT**—For swim pools or stucco. 12" x 5" x 1".

03 503 M7...\$2.25

● **POLY-FOAM PLASTIC FLOAT**—A West Coast favorite! Pure polyplastic, 12" x 5" x 1". Aluminum-backed, with the fine natural wood handle

03 504 M7...\$1.85

● **VINYL FLOAT SHEET**—10" x 16" x 5/8". The same fine vinyl plastic texture used on our Vinyl Plastic Float above. Put it on your old Vinyl Float, or use Vinyl cement to make your own plastic texture float. Cuts into four 10" x 4" faces!

03 276 M7...\$1.95

SPONGE RUBBER

8"x5"
1" THICK

10"x4"
5/8" THICK

8"x4"
3/8" THICK

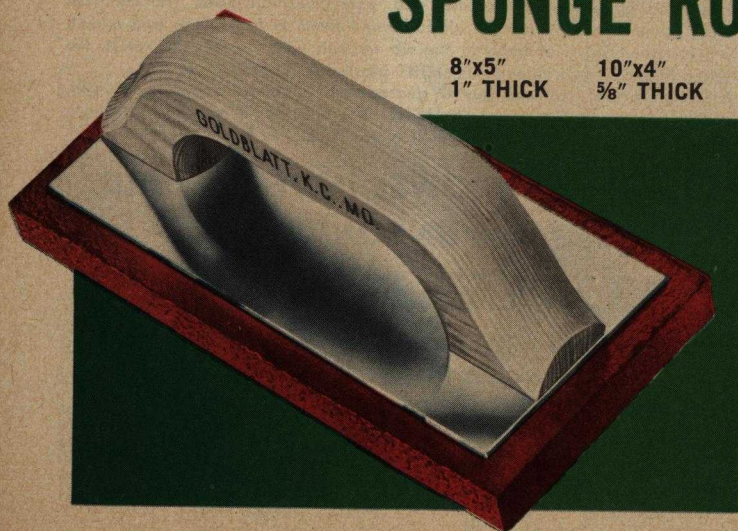

● **SPONGE RUBBER FLOAT**—Float face is 8" x 4" x 5/8" cemented to flat aluminum back.
Dense Float.....03 271 M7...\$1.70
Coarse Float.....03 281 M7...\$1.70
Sponge Pad Only 03 270 M7...\$.95

● **LONG SPONGE FLOATS**—Float face is 10" x 4" x 5/8" cemented to flat aluminum back.
Dense Texture.....03 272 M7...\$2.10
Coarse Texture.....03 282 M7...2.10
Extra Float Face (specify texture)
03 280 M7...\$1.10

● **WIDE SPONGE FLOAT**—Extra wide, extra thick, for longer wear. Float face is 8" x 5" x 1" cemented to flat aluminum back.
Dense Texture.....03 273 M7...\$2.10
Coarse Texture.....03 283 M7...2.10
Extra Float Face (specify texture)
03 290 M7...\$1.10



SOFT
BACK

● **SAND SUCKER SOFT BACK FLOAT**—Perfect for pulling the sand right out of the mud. The 10" x 4" pad is 3/4" thick, textured red sponge rubber permanently cemented to a metal reinforced flexible rubber back. Ideal for exterior sand finishing.
03 350 M7...\$2.25

MAGNESIUM HAWKS

● **"ARM SAVER" MAGNESIUM HAWKS**—These fine hawks are made of a very light very strong magnesium alloy. They are very long wearing because they are cold rolled. The corners are carefully rounded for greatest possible safety and comfort plus better service—there are no sharp corners to bend up and snag your trowel. A four-inch flange reinforces the center of the hawk gives it just the right feel. A bolt inside the handle screws securely into a 7/8" hub. Each Goldblatt hawk is equipped with a special sponge rubber callous preventer 1/2" thick. This new callous preventer is most comfortable, and holds up well.

**5 SIZES
TO CHOOSE
FROM**

● **HARD MAGNESIUM ALLOY HAWKS**

Size	Weight	Cat No.	Price
14"x14"	28 oz.	03 164 M7	\$4.25
13"x13"	28 oz.	03 163 M7	3.90
12"x12"	20 oz.	03 162 M7	3.55
10"x10"	18 oz.	03 161 M7	3.35
8"x8"	16 oz.	01 404 M7	2.75

● **SPONGE RUBBER CALLOUS PREVENTERS**—Work well on any hawk. Each a full half-inch thick.
03 149 H7....\$.25

CALLOUS PREVENTERS

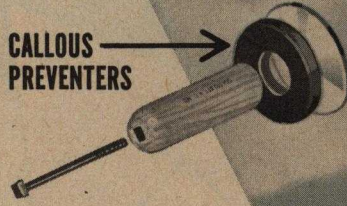

CORK FLOATS



● **WALL SCRAPER WITH REPLACEABLE BLADE**—Scrape excess mud from walls and ceilings with this sturdy tool. 22" x 4" tempered blue steel blade is long-wearing, but easy to replace by removing six nuts and bolts and sliding in new blade. Welded aluminum shank and ferrule. Scraper comes with 4 1/2' wood handle

15 386 M7....\$9.00
Replacement Blade.
15 388 M7....\$2.25

● **WOOD-BACK CORK FLOAT**—The 3/4" Portuguese cork face is cemented with an insoluble glue to the specially treated knot-free wood back. A strong, light, warp-proof float. 11 1/2" x 4 7/8". Available Carton of 4.
06 153 M7....\$3.60

● **CORK FLOATS**—Smooth, imported, virgin cork 12" x 5" x 1".
Handled06 154 M7....\$3.25
Without Handle...06 155 M7.... 2.20

REPLACEABLE BLADE WALL SCRAPER

FLOAT CEMENT



● **GOLDBLATT FLOAT CEMENT**—A special cement that grips foam rubber, sponge or plastic foam like a bulldog. It won't let go. You'll use your float right down to the metal after you attach the pad with this special formula cement. One pint can03 296 H7....\$1.75

ANGLE FLOATS

PLEXIGLASS

● **PLEXIGLASS ANGLE FLOAT**—Here is a long wearing, clear plexiglass angle float. The edges are made with a knife-sharp 90 degree edge. This float will absolutely not mark off on white coat. Made of 1/4" thick material, 9 1/2" long, 3 3/4" wide with 1" sidewalls.
03 265 H7....\$3.10

● **SQUARE EDGE STAINLESS STEEL ANGLE FLOAT**—Absolutely square! Won't mark off! Outside edges have "zero radius." The tool remains square throughout its life. Size: 9" x 4" x 3/4" sidewalls, with our best wooden float handle.
03 262 M7....\$4.90

● **ALUMINUM ANGLE FLOAT**—The most popular in the country! Square, sharp edges; tapered, beveled ends. Perfect for brown coat. 9" x 4"; 3/4" sidewalls; weight, 9 oz.03 261 M7....\$2.05

● **STAINLESS STEEL ANGLE FLOAT**—Very light, easy to use, tapered

beveled ends. 10" x 4"; 3/4" sidewalls; wt, 10 oz....03 263 M7....\$2.50

SCARIFIERS



● **"PAL" SCARIFIERS**—Completely "stress relieved" and made by a new welding method, they will last longer than ever before.

Modern plaster research has discovered that separation of the finish coat from the undercoats is always due to failure of the bond between these surfaces. This means you must scratch the undercoat to do a quality job that's going to stand-up. To help you "scarify," or scratch the undercoat properly, the Goldblatt Tool Company has developed this

rugged, stress relieved scarifier. This is the most popular scratching tool in the country. Ideal for this job. Extremely light, flexible steel tines make it easy to scratch undercoats speedily and with little effort. All welded construction. Steel handle with high carbon spring steel tines.

6" Scarifier.....	03 306 M7.....	\$1.35
8" Scarifier.....	03 308 M7.....	\$1.65
12" Scarifier.....	03 312 M7.....	\$2.25
14" Scarifier.....	03 314 M7.....	\$2.60
16" Scarifier.....	03 316 M7.....	\$2.90

WIDE BLADE ANGLE PLOWS

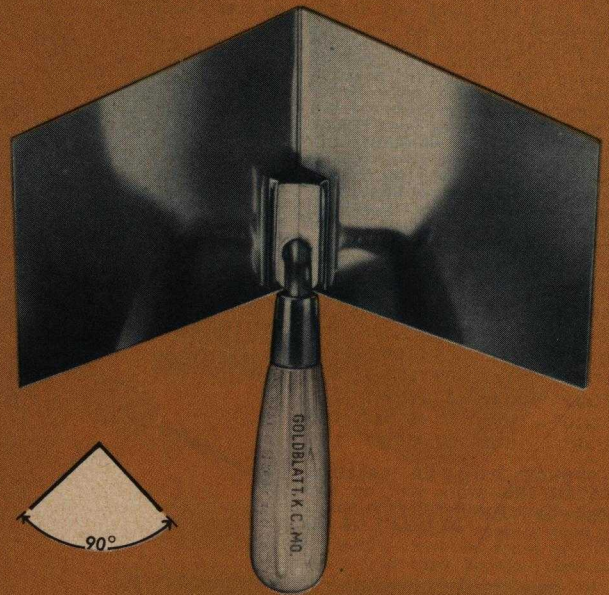

**PERFECT FOR MACHINE JOBS
— FOR THIN COAT**

\$4.95

WIDE BLADE STAINLESS STEEL ANGLE PLOWS—These tools are made of highly flexible stainless steel to resist corrosive, abrasive mixes; they won't rust or pit. Have a 90° angle between the blades.

● **THIN COAT CORNER TOOL** has 4" wide blades that taper from 5" long at center to 4¼" long at outside edge.....03 521 M7.....\$4.95

\$1.95

GOLDBLATT

ANGLE PADDLE

● **PLASTERER'S ALUMINUM ANGLE PADDLE**—Hollow center. Weighs only 6 oz. 7/8" thick; 2½" wide; 7¾" long...03 236 M7.....\$1.95

● **GOLDBLATT ANGLE TROWELS**—Made from either hard aluminum alloy or stainless steel. Originally used by English plasterers and called a Twitcher Trowel, skilled craftsmen prefer this trowel because of its knife-sharp corners. The lips are cut back about 5/8" so you can get in close and cut a sharp angle.

ALUMINUM ANGLE TROWEL—4" x 2½" x 1" Sidewall.

03 171 M7.....\$2.00

STAINLESS STEEL ANGLE TROWEL—4" x 2¾" x 1½" Sidewall.

03 173 M7.....\$2.00

● **PLASTERER'S IMPORTED ORNAMENTAL TOWELS**—Perfectly forged and tempered.

Leaf and Squares

3/8"03 194 H7.....\$2.50

1/2"03 195 H7.....\$2.50

Trowel and Squares

5/8"03 196 H7.....\$2.50

1"03 197 H7.....\$2.50

ONLY \$3.50

● **PLASTERER'S ANGLE PLOW**—

This improved tool is made of a recently developed stiff stainless steel. We form the blade from one piece of steel! This design eliminates all sharp, exposed working edges. The sidewalls are 2½" wide. The blade is set to an angle that helps you give just the right amount of pressure for clean, fast and easy inside corner forming. The steel in this tool is rust-resistant and almost self-cleaning... tough and durable. The lightweight steel mounting is centered on the blade for perfect "hang." Straight grain modern handle.

03 186 M7.....\$3.50

● **INSIDE CORNER TROWELS**—

This is a really beautiful stainless steel tool that is very light, easy to use and a cinch to keep clean. Because it is stainless steel, it won't mark off on the white coat. The blade is cut back so that you can get in really close in the angle. No rivets to make scratch marks or come loose. This tool is electrically welded. Fitted with a straight-grained, unfinished wooden handle 4½" long.

6" x 2½" x 2½"06 222 M7.....\$1.80

6" x 4" x 4"03 182 M7.....\$2.50

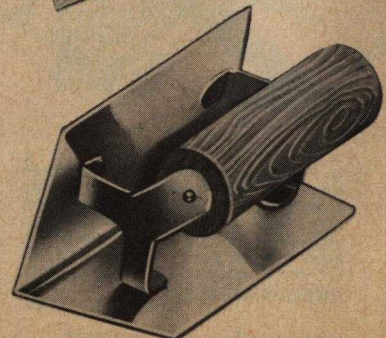
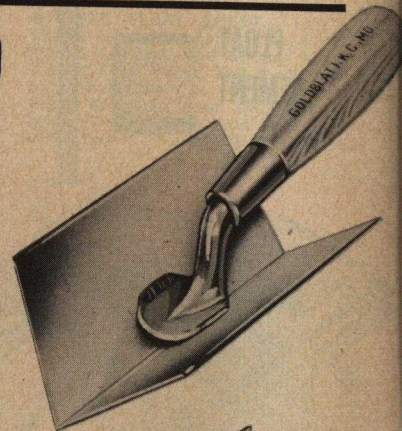

ORDER BLANK: In Center Fold

BROWNING BRUSH



● **BIG DUTCH BROWNING BRUSH**—“Stand-in” for higher priced brushes. Big brush. White Tampico 6½" x 2" x 4".
01 426 H7....\$1.55

TWO NEW FELT BRUSHES IMPROVED — LONGER LASTING

● **IMPROVED WOOD-HANDLED BLISTER BRUSH**—The rugged removable hardwood handle with a strong steel ferrule makes this brush tops. Easy to use, easy to knock down. Felts fit into a 1¼" x 7½" aluminum channel with ¼" sidewalls. An aluminum stiffener gives your felts exactly the right flex for best action on the job.
Blister Brush with two 4" x 8¾" felt pads.....03 224 M7...\$5.50
Blister Brush with one 9" x 8¾" felt pad.....03 523 M7...\$5.65

● **MOLDED PLASTIC FELT BRUSH**—All new high impact molded plastic, this felt brush is the journeyman's dream because it's light! All plastic construction means it won't pick up water (or weight). Made in one piece. A pleasure to use and to own.

Molded Plastic Brush with two 4" x 9" felt pads. 03 524 M7...\$5.50

Molded Plastic Brush with one 9" x 8¾" felt pad 03 525 M7...\$5.65

REPLACEMENT FELTS—Fit above felt holders as well as others.

Two 4" x 8¾" felt pads.....03 225 M7...\$2.25

One 9" x 8¾" felt pad.....03 526 M7...\$2.50



The ideal tools to apply water—or pick it up off newly finished surfaces. Use these felt brushes to clean door bucks or windows, eliminate cat faces or to pick up “slobbers” on walls and ceiling. Great for cement finishing too.

Skillfully made of Du Pont's Tynex tapered Nylon. Filaments are flagged and tipped. Produces a brush that will pick up and apply any material efficiently. Fine for water, alkyd, rubber, water and oil base paints.

● **LEATHER BOUND, TYNEX NYLON**—8¾" x 1½" x 4" Out.
03 106 H7....\$22.25

● **STAINLESS STEEL BOUND BRUSH**—Tynex Nylon. 8" x 1½" x 4½".....03 105 H7....\$18.50

● **REGULAR DUTCH**—For plasterers, stucco workers and painters. Tynex Nylon in rubber. 7" x 1½" x 4½".....03 101 H7....\$16.00

7¼" x 2¼" x 4½".....03 102 H7.... 16.50

● **“GEM”—LONG HANDLED SEMI-DUTCH**—4 row construction gives large water-holding capacity. Tynex Nylon. 6" x 1¼" x 3½".....03 109 H7....\$12.20

7" x 1¼" x 3½".....03 107 H7.... 15.60



● **CEMENT STUCCO DASH BRUSHES**—5" x 2¼" block. 4 rows x 8 rows Bassine Fibre 5¼".
03 114 H7....\$3.00

6" x 2¼" Block. 5 rows x 10 rows Bassine Fibre 5¼".
03 115 H7....\$3.85

● **PLASTERER'S RUBBER SPONGE**—Pure sponge rubber. Oval shaped to fit your hand. Finest sponge you can buy. Sponge 2" x 4" x 7".
03 269 M7....\$1.45

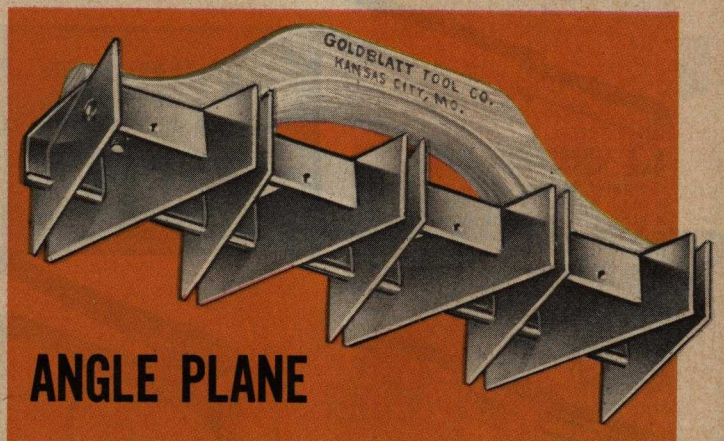

ANGLE PLANE

● **ANGLE PLANE**—This patented tool is perfect for knocking down high spots, cleaning angles and scraping down walls. Use it regularly instead of scraping with your trowel blade; you'll be many, many trowels (and dollars) ahead over the long haul. This tool is built to

take it. Nine blades, firmly attached to the body of the tool work quickly and cleanly. Each blade is a full 1¼" deep. The tool is 11" long, 4" wide. A comfortable, unfinished float handle makes it easy to use.

03 300 H7....\$4.20

STAY-TRUE® FEATHEREDGE

FINGERTIP CONTROL



Control it with your fingertips!



So well balanced, it floats on your fingers!



Patent # 3 101 502

● **ALUMINUM EDGED MAHOGANY DARBY**—A popular favorite. Aluminum binding is permanently attached. Rugged! 42" x 3½" x ⅜". Wt. 2 lbs. 8 oz.....13 716 M7....\$4.95

● **ALL MAHOGANY DARBY**—Really straight, kiln-dried, light! 45" x 3½" x ½". Wt. 2 lbs. 7 oz. 13 706 M7....\$3.50

● **DOUBLE-NOTCHED DARBY**—This Double-Notched Darby is keyed on both edges for perfect undercoats. Just the right flexibility but strong. 42" x 3¾" x ¼". Light . . . weighs only 2 lbs. 5 ozs. 13 712 H3....\$7.95

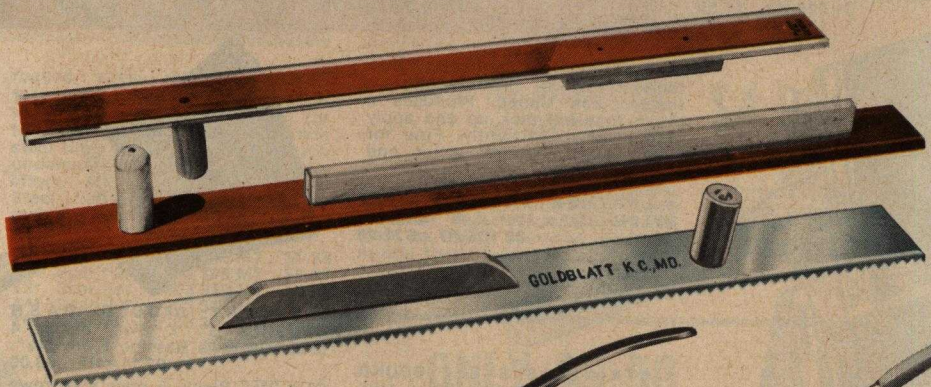

STAINLESS STEEL



● **STAINLESS STEEL MAGNETIC NAIL DRIVER**—Now 8" long, ⅜" diameter to reach into those hard-to-nail channels and corners. Has a strong, everlasting Alnico-V magnet set in the nose to grip nails tightly. The ⅝" hexagonal shank gives you a good hold on the tool. 04 156 H7....\$5.50

CHROME STEEL

¾" Nose



● **CHROME STEEL MAGNETIC NAIL HOLDER**—Heat treated steel insert with Alnico V permanent magnet. Comfortable-shape, well-balanced tool 5½" long with ¾" diameter nose.04 152 H7....\$5.50

LATHER'S TOOLS

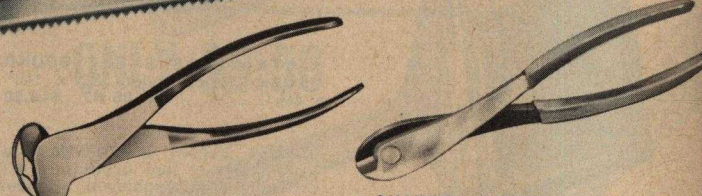

● **END CUT NIPPERS**—Here is a low cost, high quality lather's nippers. Perfectly forged and tempered tool steel that's perfect for cutting wire. Easy to handle. You can use 'em all day without tiring your hands.....04 507 H7....\$4.20

● **CHANNEL CUTTER**—With the 7" plastic dipped handles on these 8" drop forged shears you cut metal like paper. The snub nose makes cutting easy because channel metal fits deeply into the heat treated jaws where cutting force is most powerful. 02 415 H7....\$4.00



● **TODD'S WIRE NIPPERS**—Lather's favorite tool. Simple rugged construction. Hardened, high carbon steel jaws can be replaced to make the tool good as new. One screw per jaw. Cuts steel lath, tiles, all wire products. 8" long with 1⅝" jaws....04 680 H7....\$6.40 Extra 1⅝" Jaws....04 580 H7....\$2.50

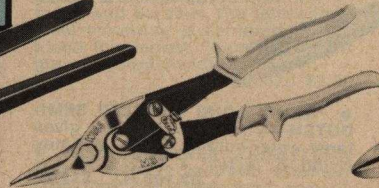

● **METAL MASTER SNIPS**—These high grade Wiss double-action aviation style snips are just what you need for metal lath. Plastic grips for comfort and safety. Left Cutting. 04 205 H7....\$4.95 Right Cutting. 04 207 H7....\$4.95 Straight and combination cutting. 04 250 H7....\$4.95 Bulldog for notching. 04'260 H7....\$4.95

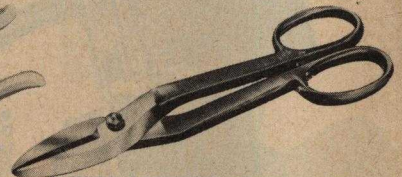

● **WISS LATHER'S SNIPS**—The finest professional cutting snips. Hot drop forged, hardened and an insert of special cutting steel "in-laid" in the jaws. #10 Snips (11½" o.a.) 04 110 H7....\$7.00 # 9 Snips (12½" o.a.) 04 109 H7....\$8.00 # 8 Snips (13½" o.a.) 04 108 H7....\$9.00 #19 Snips (12½" o.a.) 04 107 H7....\$8.50

FIVE HANDY SIZES TO CHOOSE FROM

● STAY - TRUE® MAGNESIUM FEATHEREDGE

This new tool, designed to work behind a plastering machine feels so natural in your hands that you'll never use any other kind of featheredge. This exclusive patent pending featheredge is so delicately balanced you don't have to grab it to hold it and control it. It gives you real fingertip control that makes this tool easy to use all day with less fatigue.

The 4½" wide, long wearing blade is straight and true as a die. It is designed to help you scrape off more mud while following a machine—but the extra blade width also means longer wear. Of course, the longer it wears, the less it costs in the long run.

4' STAY-TRUE...13 734 M7...\$ 7.80
5' STAY-TRUE...13 735 M7...\$ 8.80
6' STAY-TRUE...13 736 M7...\$ 9.90
7' STAY-TRUE...13 737 M7...\$10.90
8' STAY-TRUE...13 738 M7...\$12.50

● **WEDGE - SHAPE MAGNESIUM DARBY**—This wedge-shape darby is made of the strongest magnesium alloy available, tempered to just the right flexibility. It's hard as the toughest steel, but weighs only 1½ pounds. The 3' 6" long blade is tapered to give a smooth, flat surface. No grooves to catch plaster so it cleans up quickly.

13 701 M7...\$9.75

● **JUNIOR FEATHEREDGE**—Use this all - magnesium featheredge with the wedge-shape darby above. This combination prepares the job so thin and straight you can apply thin, even putty coats without fear of peeling. Rigid enough for rough darby jobs, but so light you can use it for hours without strain.

4½' (2 7/8 lbs.) 13 744 M7...\$10.45
6' (4½ lbs.).....13 746 M7...\$13.50
8' (5¾ lbs.).....13 748 M7...\$17.75

● **MAGNESIUM SLICKER**—Made of same durable magnesium alloy used for wedge-shape darby, the 3½' long slicker weighs only 22 ozs. Use to straighten and slick ceilings. No water is needed. Angle at top of tool makes it stronger; more rigid and serves as grip for easier, less tiring use. Low cost

.....13 695 M7...\$6.95

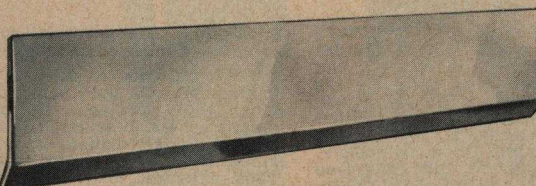
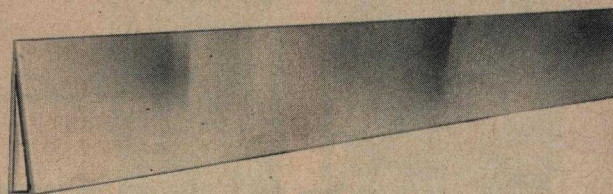
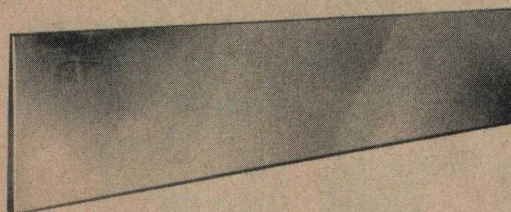

UNBREAKABLE



● ONE PIECE ESTWING SUPREME LATH HATCHET

—With Replaceable Blade. This razor sharp lath hatchet has a razor sharp replacement blade. One piece construction forged of finest steel. Exclusive Nylon-Vinyl cushion grip is molded on and will never loosen, age or wear out. Scored face prevents glancing blows, flying nails. Has rounded corners so you won't cut your fingers. Blades replace easily by removing two round head screws. 1¼ lbs.....04 300 H7...\$6.95

Extra Blades—Razor sharp.
Pack of 4.....04 303 H7... 1.00



● UNDERHILL LATH HATCHET

—The pattern many expert lathers prefer. Perfect hang, with plenty of knuckle clearance. Head is set at the most comfortable angle for overhead work. Thin blade sharpens to a razor edge. Hardened 12 row, 144 point scored head. Weighs 2 lbs., 4 oz. 04 299 H7...\$7.30

PACE-SETTER DARBIES SHINGLES & SLICKER

ONLY --\$5.45

PLASTERING SHINGLE

● **LIGHTWEIGHT PLASTERER'S SHINGLE**—Here is a lightweight, easy-to-use, magnesium plasterer's shingle that can be flexed while working. Cost little more than a wooden shingle, but outwears it many, many times. This extremely light tool has a 4¾" blade with a ¼" backbone for rigidity. Three finger grooves make it easy to handle.

36" Shingle.....13 740 H7...\$5.45
42" Shingle.....13 742 H7... 5.95
48" Shingle.....13 743 H7... 6.95

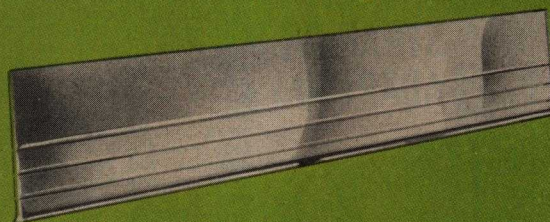

● **SINGLE BEVEL FEATHEREDGE**—Popular Wha-Lite design. Leaves angles so clean you'll seldom have to float. This fine quality tool improves workmanship on Zonolite, Perlite, Acoustic Plaster, etc. Extremely light. 4½" wide.

6' Featheredge,
(4 lbs.).....13 766 E3... 16.90



● MAGNESIUM BROWNING RODS

—These straight and true hollow magnesium rods are extremely lightweight. They can't rust, rot or warp. End caps prevent mud from loading up the tool. The blade is 4½" x 1" with one heavy duty edge for extra long wear. Edges are square and sharp. Easy to use. Write for special lengths to order.

6' Browning Rod 16 204 M7...\$16.75
8' Browning Rod 16 205 M7...\$19.50

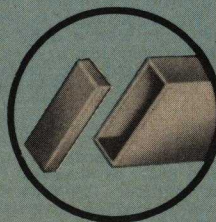

MAGNESIUM BROWNING RODS
6' size — \$16.75
8' size — \$19.50

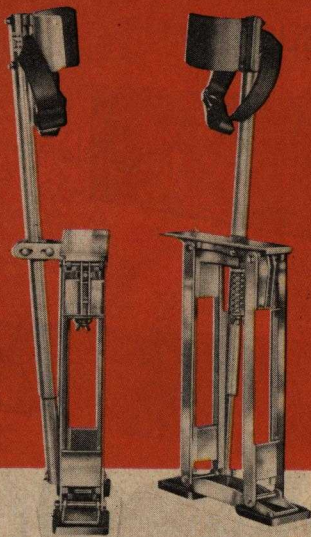

SHUJAX "ONE-HEIGHT" STILTS

\$39.00
per pair

NOTE:

12", 14", 22", 24", 26",
28" or 30" Stilts available
on special order.

**CAN BE USED WITH SHUJAX STRAP-ON
ADAPTORS DESCRIBED BELOW**

● **SHU-JAX "ONE HEIGHT" STILTS**
—These are the famous Shu-Jax fixed-height stilts in 16", 18", and 20" heights. These stilts are the same high quality as the adjustable stilts above. The only difference is these stilts do not have telescope struts to adjust height. The fixed height stilts give you every one of the "comfort" adjustments adjustable-height stilts have, but cost less. These stilts use the famous Shu-Jax mechanical ankle to walk as you walk, relax as you

relax. They have a special spring to help leg muscles offset fatigue.

They are made of selected aluminum alloys for light weight combined with sturdiness. All bolts, nuts, washers, brackets, bushings and springs are made of cadmium plated steel. Shipped with instructions, wrenches to fit adjustment, nuts and drills for mounting shoes.

16" Stilts07 233 E7.....\$39.00
18" Stilts07 234 E7..... 42.00
20" Stilts07 235 E7..... 42.00

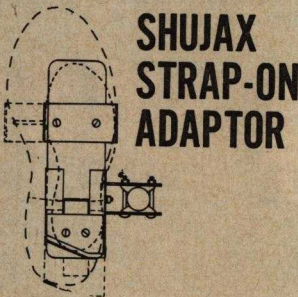

SHUJAX STRAP-ON ADAPTOR

● **SHU-JAX STRAP-ON ADAPTORS**

—With these adaptors on your Shu-Jax stilts you don't drill and bolt your shoes to the stilts. You slip your stilts on or off, or others can wear them anytime, anywhere. The adaptors bolt to the stilts. Completely adjustable for different shoe widths and lengths, a toe strap and ankle strap hold your foot securely in place. With these adaptors you can even work on stilts in overshoes. They fit any pair of Shu-Jax stilts ever made. Order adaptors with new stilts or for stilts you already own.

Per Pair.....07 108 E7.\$10.50

GYP-C-JACK BOARD LIFT

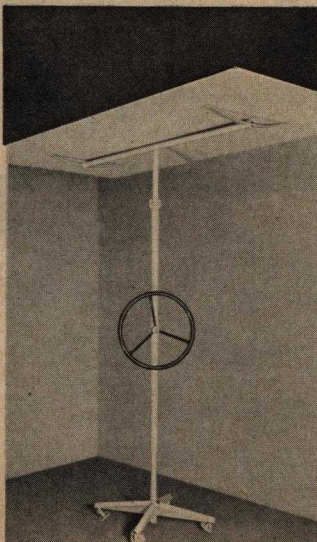

\$129.80

**Holds 16' Foil-Backed
Board or up to 200 lbs.**

● **GYP-C-JACK** — No more struggling, no more back-breaking strain to position wallboard on the ceiling. You do a neater faster job with less work with a Gyp-C-Jack. In seconds, you lift a 4' x 16' gypsum wallboard into place for nailing. Easy to use. Time saving. Has 3 simple parts: 1) 21" x 21" steel base with creeper casters; 2) spring steel spider-arm top to hold gypsum boards; 3) jack assembly to lower or raise top. Won't get out of order. Gyp-C-Jack low height is 6', raises to 9'. F.O.B. Cedar Rapids, Iowa.

Gyp-C-Jack 15 151 E6.....\$129.80
1' extension 15 152 E6..... 2.80

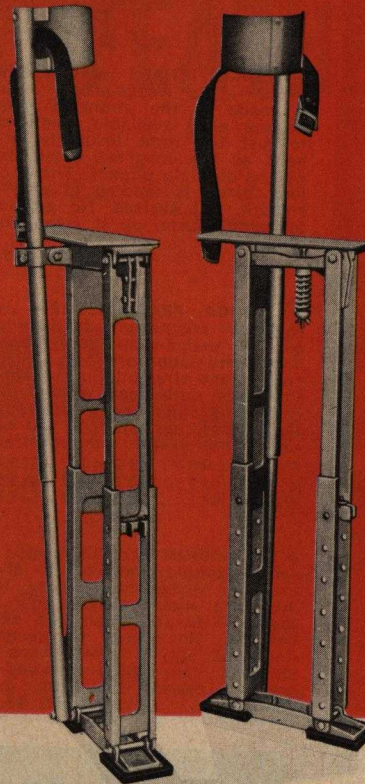

SHUJAX "SNAP-LOCK" ADJUSTABLE

\$63.00 A PAIR

**CAN BE USED
WITH SHUJAX
STRAP-ON-
ADAPTORS
DESCRIBED
BELOW**

● **SHUJAX SNAP-LOCK ADJUSTABLE STILTS**

—Adjust the height of these new stilts instantly; no bolts to loosen or remove, nothing to lose. Just squeeze two spring-loaded tabs to adjust these stilts from 18" to 30" height in 2" steps. They have every comfort and convenience adjustment of the regular

adjustable Shu-Jax Stilts shown above, plus this new, positive locking Snap-Lock. Made of extremely light, extremely rugged aluminum, these stilts are easy to use—you get so used to them, you hardly know you have them on.....

.....07 109 E7.....\$63.00

WALKUP ADJUSTABLE TRESTLE



● **SHUJAX ADJUSTABLE TRESTLE**

—This bench is adjustable every two inches from 18" to 32"; a built in "step" makes it easy to get on the trestle, no matter what height it's set at; folds to only 6 1/2"; 9 1/2" x 48" top 1/4" masonite with rough side up is skid proof; adjusts for height without a single tool; all leg frames and braces are fitted with bushings so they bolt tight, but won't bind. Legs adjust every two inches. They can be set

at different heights for working on uneven surfaces. Rubber feet won't skid on the slickest surface.

This is the ideal trestle for dry-wall workers, electricians, plasterers, painters and other "inside" trades. Accessory extensions are available to increase trestle height every 2" from 34" to 44". Adjustable Trestle

Leg-Extensions 07 119 E7.....\$54.00
07 118 E7.....\$21.00

SHUJAX ADJUSTABLE STILTS



\$57.00
A PAIR

CAN BE USED
WITH SHUJAX
STRAP-ON-
ADAPTORS

NEW!
VULCANIZED
SOLES

● **SHU-JAX "WALKING SCAFFOLD" STILTS**—Here are the only stilts made with genuine "walking action." The time-tested construction of these very lightweight stilts makes it possible to wear them for long periods with no unusual leg fatigue. These stilts have a mechanical ankle and special spring to supplement your leg muscles. The spring is adjustable to your weight. Bend your leg forward, the stilt foot stays solidly on the ground, while the "stilt ankle" flexes.

These stilts are completely adjustable to your needs. Adjustable every inch from 18" to 28" height.

They have more "comfort" adjustments than any other type of stilts on the market so this means that you get exactly the perfect balance and feel you need to work easily. Your shoes remain permanently attached to these stilts.

They are made of selected aluminum alloy for lightweight combined with sturdiness. All bolts, nuts, washers, brackets, bushings and springs are made of cadmium plated steel. Shipped complete with full instructions, wrenches to fit all adjustment nuts and drills for mounting shoes.....

.....07 107 E7....\$57.00

ELEVATOR STEADY STILTS



ONLY
\$41.25
A PAIR



4½" x 7¾" Cast
Aluminum Base
Has Three Solid
Rubber Treads!

● **ELEVATOR STEADY STILTS**—Extremely light, adjustable stilts with thick, non-skid rubber base. All aluminum, these stilts weigh only 4 lbs. each. Fully adjustable from 6" to 26". Individual stirrups adjust to give you the best feeling of balance. These stilts are described as "the easy way to plaster a ceiling without getting down to move the ladders and scaffolding".

They make scaffolding obsolete. Plasterers, dry-wall workmen, lathers, painters, acoustical tile applicators—almost all crafts use them. Get your work done in less time, forget about setting up and tear-

ing down scaffolds—and you won't scuff doorways or walls because you're not swinging heavy planks around.

STEADY STILTS
(Pair)07 106 M7....\$41.25

REPLACEMENT PARTS—
Heel Straps (Pair) 07 236 M7....\$1.05
Toe Straps (Pair) 07 237 M7....\$1.05
Stilt Tube 07 242 M7....\$4.10
Stilt Pad 07 241 M7....\$4.85
Foot Casting (Left) 07 245 M7....\$5.25
Foot Casting (Right) 07 246 M7....\$5.25
Base Complete 07 239 M7....\$9.80
Rubber Pads Only 07 243 M7....\$2.50

DRYWALL T-SQUARE TWO STYLES

WITHOUT OR WITH LIP ONLY

\$9.50

● **DRYWALL T-SQUARE**—Our gold-anodized T-Square has at least 6 advantages over every other make: 1, easy-to-read black on gold markings; 2, stud locator holes to mark board for fast nail driving; 3, notched head lets you cut a 4" blade in one sweep; 4, use the 2" blade to cut both sides of an outlet box without moving your square; 5, blade springs straight no matter how you flex it; 6, anodized finish wears longer. Blade measures up to 48", head measures 1" to 6" on short end, 2" to 16" on long end. Markings in inches and eighths.
05 120 M7....\$9.50

● **DRYWALL T-SQUARE WITH LIP**—Every feature of above plus an extra long 1/2" lip on head to ride the edge of wallboard with tapered, rounded edges as shown in illus.
05 121 M7....\$9.50



NEW!

WITH 1/2" LIP

three stud locator holes at 16", 24", 32"

2" BLADE WIDTH

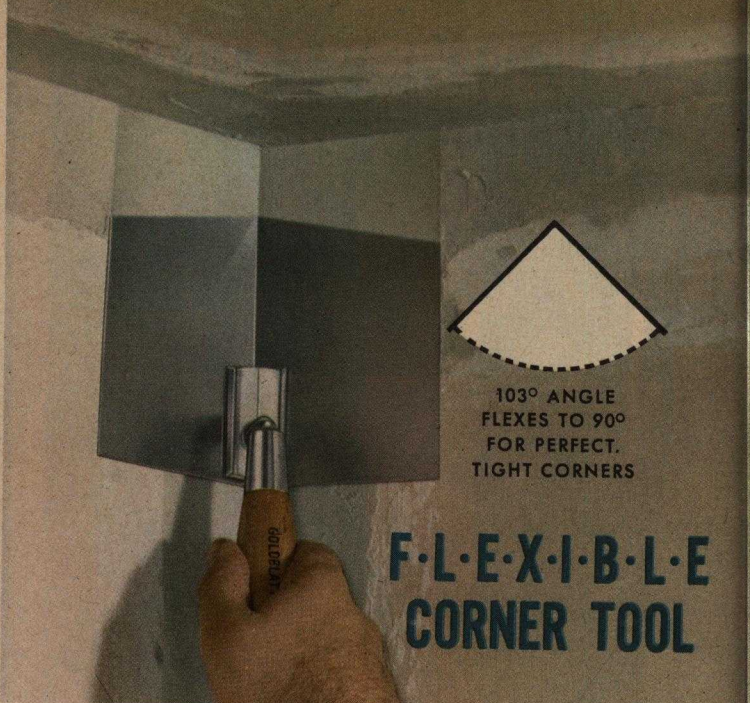

103° ANGLE FLEXES TO 90° FOR PERFECT TIGHT CORNERS

FLEXIBLE CORNER TOOL

● **CORNER TAPING TOOL**—Highly-flexible stainless steel. Blade formed from one piece of steel! This design eliminates all sharp, exposed working edges, eliminates tape snagging. Sidewalls are a full 4" wide. Blade is set to the proper

angle for clean, fast and easy inside corner taping. Steel is rust-resistant and almost self-cleaning, tough and durable. Lightweight aluminum mounting has perfect "hang."

05 520 M7....\$ 3.90



CORNER TAPE CREASER



● **CORNER TAPE CREASER**—Makes both inside and outside corners a snap. This sturdy, lightweight aluminum tool hangs on a roll of tape while doing corner work, or mounts on a bench. Just pull the tape through as you need it and cut it off. It's as easy as that. Makes sharp, true corners, eliminates touch up work. There are no wrinkles in tape to get air bubbles and show later after painting05 525 H7....\$1.25



"BLAZER" TAPER

NEW!

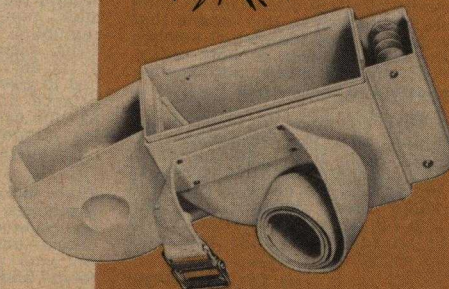

● **BLAZER TAPER**—Takes the weight off your arms and wrists, puts it on your belt so you have two hands free to apply tape and remove excess mud. All-plastic, the Blazer is very light, even when filled with tape and mud. The open top lets you scrape excess mud back into the taper and shows how much mud and tape remains at all times. Only 5" x 8" x 20" overall, the Blazer weighs only 3 1/2 lbs. loaded with tape. Comes complete with fully adjustable belt, ready to go to work.
Blazer, Right Hand 15 336 H7....\$46.50
Blazer, Left Hand 15 337 H7....\$46.50
Blazer with plastic apron to protect clothes while taping. 15 325 H7....\$49.50
Plastic Apron only 15 326 H7....\$3.00

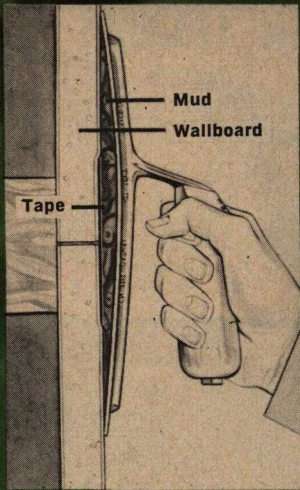

Our drywall trowel helps you make perfect joints every time because each trowel has a "built-in" curve (exaggerated in this drawing) that feathers the mud for you.



$\frac{3}{16}$ " ACTUAL BLADE CURVATURE

CURVED BLADE DRYWALL JOINT TOOL

ROCK-RIB® CONSTRUCTION

5 SIZES

● **CURVED BLADE DRYWALL TOOL**
—For men who prefer a flat tool for finishing dry wall joints. Tem-

pered, flexible spring steel blades have approximately $\frac{3}{16}$ " concave bow, (see photo) for perfect shearing. Blades are permanently fastened to the light-weight aluminum shanks with ten steel Power Pins. Gives a perfectly balanced edge!

8" x 4 1/2"	05 508 M7	\$5.40
10" x 4 1/2"	05 510 M7	\$5.40
12" x 4 1/2"	05 512 M7	\$5.55
14" x 4 1/2"	05 514 M7	\$5.90
16" x 4 1/2"	05 516 M7	\$6.60
● NEW! RAZOR STAINLESS STEEL DRYWALL TROWEL —12" x 4 1/2"		
	05 209 M7	\$6.65

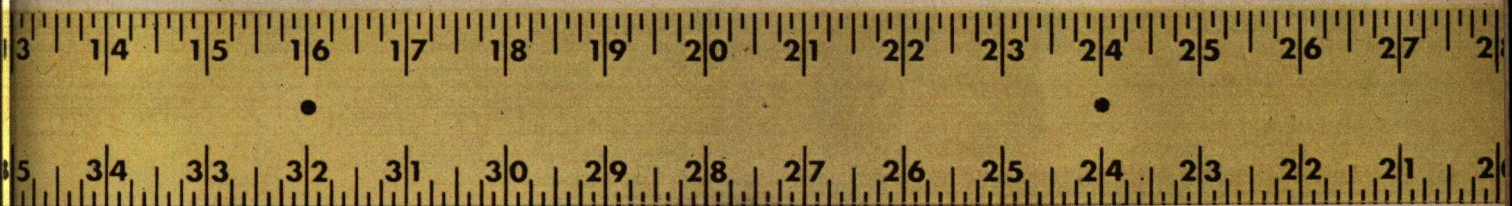

BANJO TAPERS

DRY TAPE

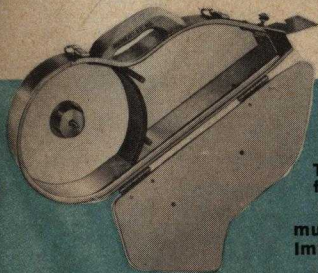

● **DRY TAPE BANJO**—Drop most 500' tape rolls in the dry tape compartment; they center on the built-

in spindle, and the tape never gets soggy, no matter how long it's in the machine. Flips open or closed on hinges, a flick of the fingers locks or opens the two hasps. Made of deep drawn aluminum, the metal to metal seal is leak-proof, trouble-free. Threaded for ceilings or walls, the Goldblatt handles are easy to use. Use the thumbscrew to apply

just the amount of mud you want with the tape.
Dry-Tape Banjo.

15 301 M7...\$25.95

● **WET TAPE BANJO**—Same as above but both tape and mud store in the same compartment as preferred by many tapers.
Wet-Tape Banjo..15 302 M7...\$25.95

Visible Tape Roll so you can check tape remaining.

Tape threads two ways: for ceilings or for walls.

mud capacity. Improved, larger

WET TAPE



\$25.95

TAKES MOST 500' TAPE ROLLS

Hinged Lid with hasp lock for fast, one-hand filling.

HIGH SPEED OUTLET CUTTER

CUTS OUTLET HOLES
IN SECONDS

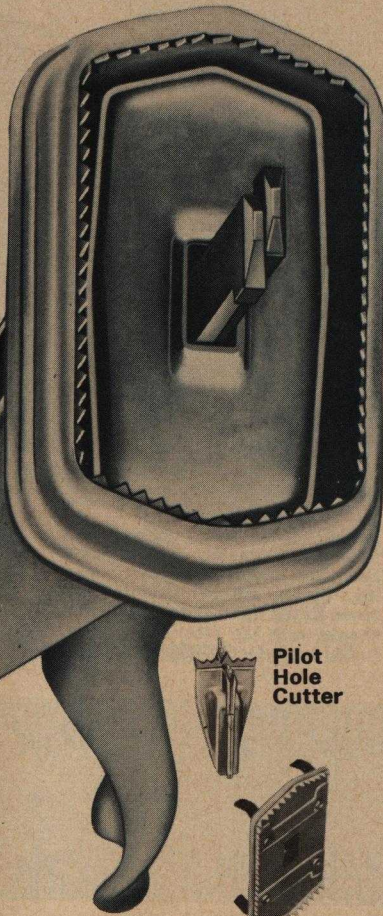
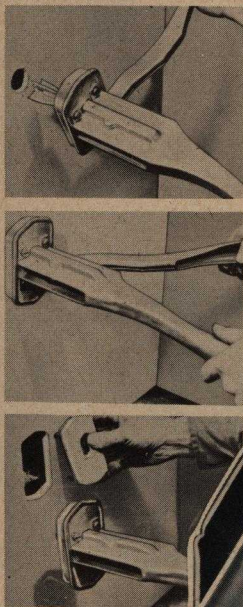

● IMPROVED

4-sided Male Cutter

3-sided Male Cutter



Pilot
Hole
Cutter

See important new size listed below . . . conforms to new 1967 Code Changes.

● IMPROVED HIGH SPEED OUTLET CUTTER—A fast worker takes at least 90 seconds to saw an outlet hole by hand. With this tool you do it in 30 seconds. Save an hour's labor for each 60 outlets!

You snap the four-sided cutter plate into outlet box before nailing up board. After board is up, make a mark near the center of the box, then use the Pilot Hole Cutter on the tool to cut through board—and don't worry, your pilot hole can be as much as 1/2" off in any direction, the cutter still makes a perfect outlet hole. After cutting through board insert the tool as shown in the second photo above, squeeze the handles and the job is done. Takes less time to do than it does to read about it.

Each hole is cut out cleanly: no torn paper to patch, no messed up boxes to repair, and no learning time needed. Pick up the tool and use it right the very first time. Cuts perfect holes in 3/8", 1/2", 5/8" wallboard.

IMPROVED CONSTRUCTION — Newly reinforced sear plate inside the tool gives longer life to working parts. All models are cadmium plated steel.

● STANDARD HIGH-SPEED OUTLET CUTTER—Cuts a 2 3/8" x 3 1/2" hole. Complete with pilot hole cutter, one 4-sided male cutter, one 3-sided male cutter for cutting duplex openings. 15 272 H7...\$24.95

● Extra Male Cutters
Three-Sided15 296 H7...\$ 2.50
One Pkg. of 12.....15 292 H7...\$23.50
Four-Sided15 297 H7...\$ 2.50
One Pkg. of 12.....15 295 H7...\$23.50
Female Cutter Head

15 282 H7...\$ 5.50
● ROUND HIGH-SPEED OUTLET CUTTER—Cuts 4 1/8" diameter outlets. Complete with two Round Male Cutters and pilot hole cutter.
Male Cutter 15 270 H7...\$24.95
Female Cutter Head 15 290 H7...\$ 2.75

15 280 H7...\$ 5.50
● SPARE PILOT HOLE CUTTER—Use with any model described here15 275 H7...\$ 2.75
● MALE CUTTER REPAIR KIT—Extend the life of male cutters. Kit contains 10 spring clips, eight screws15 277 H7...\$ 1.15

● NEW CODE OUTLET CUTTER—Use this tool to cut outlets for the plaster ring required by the new National Electric Code for 4x4 outlet boxes. Complete with two 4-sided male cutters pilot hole cutter. 15 276 H7...\$24.95
Male Cutter15 286 H7...\$ 2.75
Female Cutter ..15 287 H7...\$ 5.50

UTILITY SAW



HEAVY BLADE
WON'T BEND

● UTILITY SAW—6" blade cuts wallboard, wood, masonite, plywood, etc. Comfortable hardwood handle. Sharp point for easy penetration. Not necessary to drill before using. 05 143 M7...\$ 1.90



● WALLBOARD SAW—With five teeth to the inch, this Swedish steel saw cuts through wallboard, gypsum lath and the new backing board for thin coat plasters quickly and easily. Blade is 15" long, 19 1/4" overall. Comfortable hardwood handle.....15 801 H7...\$5.10

● UNBREAKABLE HANDLE—Laminated handle only. Fits wallboard saw.

Handle Only. 15 802 H7...\$2.10



UTILITY KNIFE & BLADES

● GOLDBLATT UTILITY KNIFE—Perfect for any cutting job. "No Slip" handle fits the hand to make this knife comfortable and easy to use hour after hour. Adjust the razor sharp blade to any of four positions—will not slip. Utility Knife with one blade. 05 144 M7...\$.69

● UTILITY KNIFE BLADES—These strong, razor-sharp blades fit Stanley or Goldblatt utility knives. Buy in quantity and save \$2.40.

Pack of 5.....05 147 M7...\$.50
Ctn. of 100 Blades. 05 145 M7...\$7.60



Strips cleanly
close to
the edge

● WALLBOARD STRIPPER—At last, a tool that trims the edge of a gypsum board panel neatly. The two steel wheels on this tool perforate both sides of a drywall board so that you can snap off the trimmed edge cleanly, neatly.

The comfortable wooden handle guides the wheels accurately. Cuts as deep as 4 1/2" along the top edge of the tool makes setting easy. Just loosen a thumbscrew.

Stripper for 3/8", 1/2" Board 15 265 H7...\$ 9.95
Stripper for 1/2", 5/8" Board 15 267 H7...\$10.55

CIRCLE CUTTER

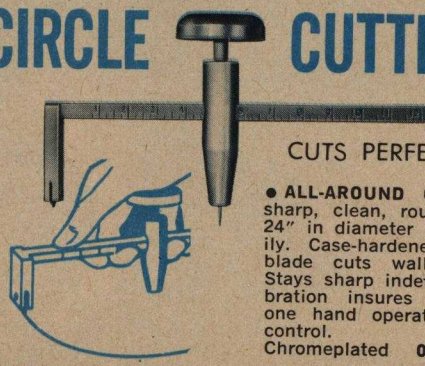

CUTS PERFECT CIRCLES

● ALL-AROUND CUTTER — Cuts sharp, clean, round holes up to 24" in diameter quickly and easily. Case-hardened steel cutting blade cuts wallboard perfectly. Stays sharp indefinitely! 1/8" calibration insures accuracy. Easy, one hand operation and perfect control. Chromeplated 05 141 H7 \$ 4.25

KNUCKLE SAVER™ HAMMERS

NEW
HEAVY
HEAD



\$5.40

● **TARGET HEAD HAMMER**—Improved hammer with a heavy duty 16 oz. offset head and a blade that's tough as they come. The improved knuckle clearance of the offset head ends scrapes. Circular target style grooves on the rounded head dimple the board without breaking the paper. Beautifully balanced with a 14" handle so you can drive nails all day long with minimum effort.
Heavy Head Hammer.

05 162 M7...\$5.40

14" Handle Only.

05 165 M7...\$.75

● **CHECKER HEAD HAMMER** — Properly rounded and checkered head dimples wallboard perfectly for proper nailing and easier spotting. Head won't bruise wallboard or break the paper. The 14" hickory handle is offset to eliminate rapped, sore knuckles. Wedge-shaped hatchet blade has handy nail puller, helps shift or pry board into place. Perfectly balanced. Made of rugged Steel. Adze Eye holds handle securely.

05 164 M7...\$6.50

16" Handle Only...05 167 M7... 1.05

● **FIRST ALL-STEEL DRYWALL HAMMER**—The first all-steel drywall hammer ever; one-piece solid steel forging gives you the strongest hammer known. Has a crowned, scored face to make nailing easy, prevent breaking the surface of wallboard. Exclusive nylon-vinyl cushion grip won't loosen, come off or wear out. Angled blade on a perfectly balanced, polished steel hammer makes this a fine tool.

05 160 H7...\$6.75

● **WESTERN DRYWALL HATCHET** — Favored by most drywall men in the West, this forged hatchet made by Plumb, has a crowned face with flat checkers and a 2 1/4" razor sharp blade. This 13" red handle is well-balanced, easy-to-use.

05 168 H7...\$7.75

● **OUTLET BOX HAMMER**—Forged in one piece with a long poll neck, to reach nails in an outlet box, this polished all-steel hammer saves time on the job. A straight claw makes nail-pulling easy. Genuine sole leather cushion grip, just right balance.....

05 615 E3...\$5.90

● **16" FRAMING HAMMERS**—These long handled, forged in one piece all-steel framing hammers give you extra reach, extra power, extra strength. The milled face and extra weight in the head helps you drive nails straight and fast. The shock-proof Nylon-vinyl grip is a joy to use—it won't loosen, come off or wear out.

28-oz. Framing Hammer.

07 416 E3...\$7.50

22-oz. Framing Hammer.

07 417 E3...\$6.95

● **EXTENSION BLADED 6' FOLDING RULE** — A heavy duty, lightweight 6' rule that withstands hard, daily use. Graduated brass slide on first section extends full 6". Brass plated, riveted lock joints eliminate end play. The end caps and end strike plate are solid brass. Markings are embedded in the wood and protected by a tough epoxy coating. Marked both sides, both edges to 16ths, with red stud markings on 16" centers. Has brass plated hook.

09 318 H7...\$3.50

Brass plated, riveted joints 6" extension.

FOOT LIFT



\$4.25



● **WALLBOARD FOOT LIFT** — An easy-to-use tool that's easy to scoot around on your foot. It's a honey. No parts to wear out. It's all one piece, so it will last forever. Always sits right side up. Doesn't matter if you drop it, kick it, throw it or push it, it always

turns itself right side up. Positive control. With the "stirrup" on this lightweight aluminum tool you can put it where you want it with your foot. A husky aluminum casting, 11 7/8" long, 5 1/4" wide overall.

05 173 H7...\$ 4.25

ROLL LIFTER

IMPROVED!
Pat. 2,692,753



NOW 1" LIP!

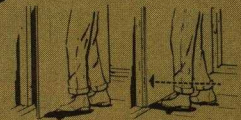

● **WALLBOARD ROLL LIFTER**—An extra pair of hands for you. Just step down on roll lifter and you raise wallboard up as much as 3", move it in tight against the wall for easy one-man handling and nailing. It's weighted nose-

down to get under the board easy. Moves 2" forward each time you use it. A strong 15 gauge steel tool with a free-riding tubular steel wheel, it is small and light enough to carry in your nail bag. One Roll Lifter 15 171 H7...\$4.25

05 171 H7...\$4.25

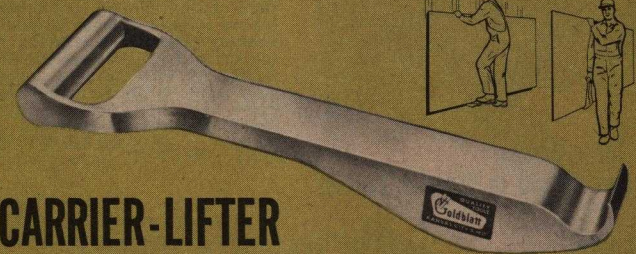

CARRIER-LIFTER

● **WALLBOARD CARRIER - LIFTER**
Two tools in one. Carry a full size board with this rugged, lightweight cast aluminum tool. Set the board in place, and your carrier becomes an easy-to-use

lifter. Just step down to lift dry-wall into nailing position. The rugged, cast aluminum weighs only 2 lbs. No parts to wear on this one-piece tool!

05 170 M7...\$ 5.25

LUFKIN POWER TAPES

● **LUFKIN POWER TAPES**—Pull blade out, it stays out; push down button, blade locks securely at any point; press nameplate button, blade returns under full control. Black on white markings protected by permanent epoxy coating. Blade is 3/4" wide. Foot figures and red stud markers on 16" centers; top side graduated in feet, inches and 16ths, first foot in 32nds; bottom side graduated to 16ths on top edge. Ten reference tables printed on back. Removable belt hook on black-trimmed chrome case. 12' Power Tape.....

05 232 H7...\$4.50

● **16' POWER TAPE**—Same as above, blade 16' long, but without reference tables.

16' Power Tape. Blade Locks in Place returns under control.
05 233 H7...\$5.25

OR INSIDE MEASURE		READ AT CASE #1	
INDEX	TABLE	TABLE	AT
12'	12'	12'	12'
16'	16'	16'	16'
20'	20'	20'	20'
24'	24'	24'	24'
28'	28'	28'	28'
32'	32'	32'	32'
36'	36'	36'	36'
40'	40'	40'	40'
44'	44'	44'	44'
48'	48'	48'	48'
52'	52'	52'	52'
56'	56'	56'	56'
60'	60'	60'	60'
64'	64'	64'	64'
68'	68'	68'	68'
72'	72'	72'	72'
76'	76'	76'	76'
80'	80'	80'	80'
84'	84'	84'	84'
88'	88'	88'	88'
92'	92'	92'	92'
96'	96'	96'	96'
100'	100'	100'	100'

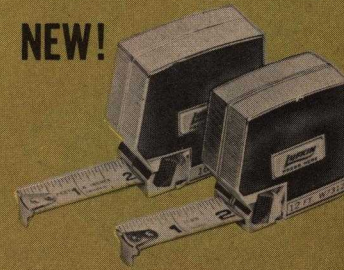

NEW!

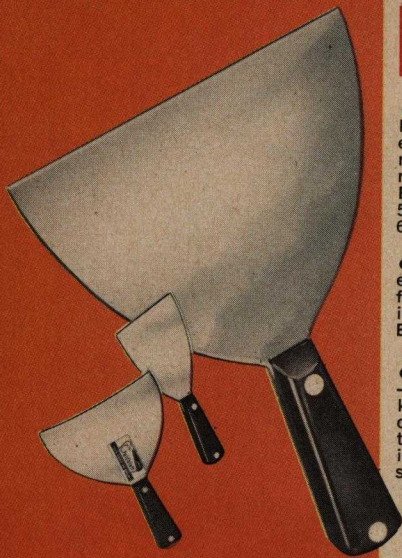

KNIVES

• **ELASTIC KNIVES** — Flexible, high carbon steel blades hardened, ground and polished to a mirror-like finish. Handles are molded of shatter-proof plastic. Brass "Hammer" head.
 5" Knife.....05 530 H8...\$2.80
 6" Knife.....05 533 H8...\$3.25

• **ELASTIC KNIVES** — Hardened, electrically tempered and ground for flexibility. Shining mirror finish retards rusting. 4" Square Blade05 544 H8...\$2.00

• **SHEAR BLADE SPOTTING KNIFE** —This special brass headed 6" knife has a concave shearing curve of .050" in the blade. A particularly valuable knife for shearing excess joint cement from nail spots05 538 M7...\$3.95

• **TRIO: THE REVOLUTIONARY 3-IN-1 DRY WALL FINISHING TOOL** —This amazing "triple threat" knife shears! feathers! and finishes! It has three interchangeable and replaceable blades: An 11" x 4" blade with a concave edge shears, feathers and finishes; an 11" x 4" blade with a straight working edge for flat work and tight shearing or skimcoating and an 8" x 4" concave blade shears and finishes.

Each blade locks securely and quickly into the light-weight aluminum blade clamp by means of two small brass wing nuts. Joint tape can be slipped into the blade clamp to shim blades to most any desired "bow." Every blade is of the correct gauge steel for proper flexibility. The durable, comfortable Tenite II plastic handle hangs just right for perfect balance. Complete with 3 stainless steel blades05 450 M7...\$4.95

• **ADVANCE TAPING KNIVES**—The finest wide blade knives made. The blade of tempered steel bows just right for perfect feathered joints. A sturdy steel rib prevents the knife from taking a "set" as frequently occurs with cheap knives. Comfortable wood handle.
 8" Knife05 608 H8...\$2.69
 10" Knife05 610 H8...\$3.46
 12" Knife05 612 H8...\$4.20
 14" Knife05 614 H8...\$5.25

• **AMES FEATHERLITE KNIFE**—Wide flexible spring steel blade mounted in a rust-proof, easy to flex aluminum mounting attached to a strong, straight-grained wood handle. You can "set" the blade for perfect shearing action. Blade is 3 1/4" deep.
 8" Featherlite...05 248 H7...\$3.10
 10" Featherlite...05 250 H7...\$3.50
 12" Featherlite...05 252 H7...\$3.90

• **LONG HANDLED BROAD KNIFE** —This lightweight tool has a spring steel blade 7" wide with rounded corners attached to a magnesium handle to give you a tool 17 1/2" long. Reinforced with a light-weight aluminum casting where the blade is attached to the handle. This tool wears out before it breaks05 440 M7...\$3.25
 Extra Blade05 442 M7...\$1.00

TRIO: FINISHING TOOL

Three Blades,
One Curved to Shear & Feather

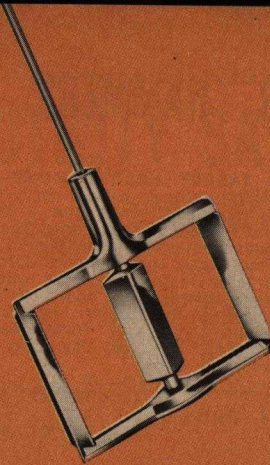
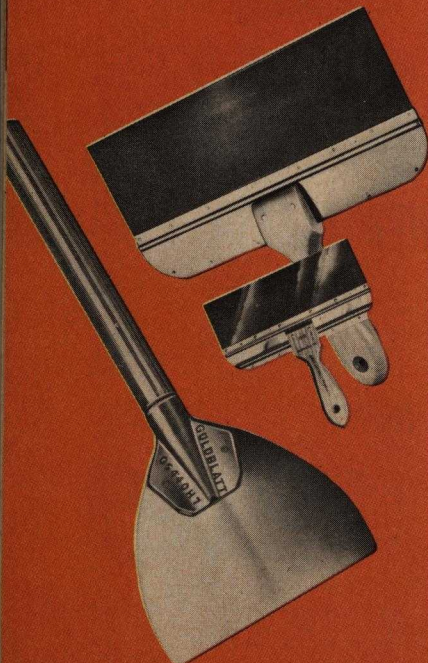

FOLDSTIR

MUD MIXER

Lifts, Folds and Blends Drywall Mud Thoroughly, Quickly with no Air in the Mix

• **FOLDSTIR**—Mix any kind of drywall mud, acoustic, premix quickly, thoroughly, lump free with this paddle. Fits inside 5 to 55 gallon drum. Chucks into any 1/2" or larger slow speed drill (about 500 rpm shaft speed) Shaft 1/2" x 30" long overall. Paddle is 9 3/4" wide, 6 3/8" deep. Blades shaped to fold, lift and stir material for thorough mixing.....15 315 M7...\$9.95

JIFFLER MIXERS



• **JIFFLER MIXERS**—These scientifically designed 5-fin dispersal wheels mix drywall mud quickly. Lower wheel cuts upward, upper wheel cuts down creating counter flow to disperse lumps fast. Sizes shown are for 12" to 15" drums. Each unit takes one upper and one lower wheel.

Units are made of high stress, plated carbon steel. Shafts will not slip in chuck. Shipped knocked down. Instructions included.

For 3/8" or 1/2" drill (450 to 1200 rpm). Two 5" wheels. 3/8" x 24" shaft. Mixes 5 gal. batch in 2 minutes15 310 H7...\$9.15

For 1/2" drill (450 to 750 rpm) Three 5" wheels. 3/8" x 24" shaft. Mixes 5 gal. batch in 1 1/2 mins. in 12" diam. container.
 15 311 H7...\$12.70

For 1/2" Heavy Duty Drill (450 to 750 rpm) 1/2" x 24" shaft. Two 6 1/2" wheels. Mixes two-sack batch in 1 min. in 12"-15" container.
 15 312 H7...\$18.50

STAINLESS
STEEL

• **JIFFY MUD & RESIN MIXER**—Won't mix air into your mud or epoxy; used properly material won't splash out of container. Produces a smooth, lump-free, bubble-free mix in just a few seconds when chucked into any 1/4" or 1/2" drill with recommended speed of 450 to 650 rpm.

The two vertical blades keep the mixing action inside the cage of the tool, making this mixer so efficient it mixes a complete five gallon can of materials in less than 60 seconds. The "sealed ring" design prevents puncturing or damaging your mixing container.

• **STAINLESS STEEL JIFFY MIXER** —Length overall, 10 1/2"; 1/4" shaft; bottom diam, 2 3/8"; top diam, 2 3/8"; head depth, 2 1/2"; fits small containers.

S.S. Jiffy Mixer...15 308 H7...\$3.60

• **NICKEL PLATED JIFFY MIXER** —Length overall, 21"; 1/2" shaft diam; bottom diam, 5"; top diam, 4 1/2"; head depth, 5"; fits 3 gallon containers or larger.

N.P. Jiffy Mixer 15 309 H7...\$15.95

MASHERS

ROUND
HEAD

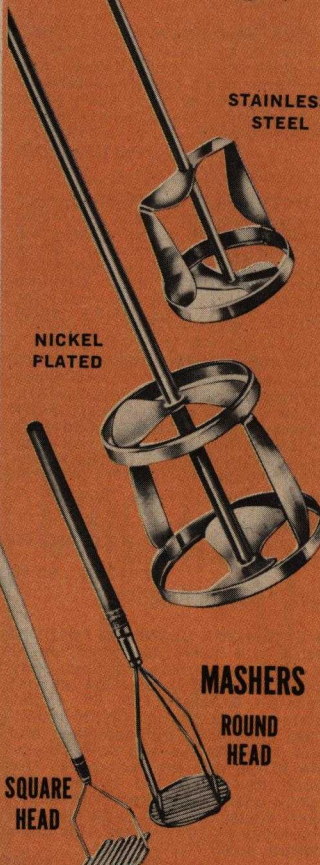

SQUARE
HEAD

• **DRYWALL MUD MASHER**—This is the perfect lightweight tool for mixing joint cement evenly for easy application. Made of steel wire. Rugged wooden handle. Has 5" diameter head, 24" long overall05 101 H7...\$2.85

• **SQUARE MUD MASHER** —24" long, 5" square. Made of heavy duty wire that wears and wears. Excellent for mixing small batches. Preferred by many workmen.
 05 103 H7...\$2.35

MUD HOLDERS

● **STAINLESS STEEL MUD HOLDER**—The hard, abrasion-resistant stainless steel blade stands up to constant scraping of 5", 8", and 11" knives. Hawk is 12" x 6" with a 1½" lip. The comfortable handle fastens securely but detaches easily. The handle's sponge rubber "doughnut" cushions the load and serves as a callous preventer. Designed specifically for dry wall work.....05 460 M7.....\$3.10

● **PLASTIC MUD PAN**—This 10½" plastic mud pan has a replaceable steel blade set into the edge for wiping your knife. The pan never wears out. Made of hard, long-wearing plastic, it won't break if dropped, is unaffected by temperature changes or chemicals in the mud—will outlast any other mud pan you've ever owned. 12" long, 4⅝" wide at top, tapering to 10½" x 3" at bottom; 3¼" deep.
05 206 H7.....\$2.70

● **12" MUD PAN HOLDER**—All aluminum, this lightweight mud pan holder hooks to your belt to hold your mud pan where you can get at it easily, leaving your hands free to work. Has a hook below the pan to hold a roll of tape. Weighs only 11½ ounces.....05 207 H7.....\$4.95

● **DOUBLE-BLADED 12" MUD PAN**—This steel mud pan is equipped with long wearing spring steel blades on two sides. Blades are permanently welded to pan to give you twice the life and more for your money! Ends are tapered and all edges rolled 4⅝" x 13" at top; 3½" x 12" at bottom; 2½" deep.
05 208 M7.....\$1.75

● **STEEL-EDGED MUD PANS**—Replacement spring steel blade built into pan. When worn out, replace blade, not pan. Galvanized steel 5" wide at top, 3" at bottom, 3" deep. Ends tapered. All edges rolled.

10" Pan05 200 H7.....\$2.60
12" Pan05 202 H7.....\$2.90
14" Pan05 204 H7.....\$3.25
10" Blade Only.....05 201 H7.....\$.40
12" Blade Only.....05 203 H7.....\$.40
14" Blade Only.....05 205 H7.....\$.40

● **WON'T LOAD SANDPAPER**—Fits all sanders on this page. The low cost way to buy sandpaper. 80 grit will not load up with mud.
30" x 4".....15 502 H7.....\$ 4.00
150' x 4".....15 503 H5.....\$12.55

● **GOLDBLATT PRECUT SANDPAPER**—11" x 4½" sheets of 80 grit sandpaper precut to fit all Goldblatt-made sanders on this page. Costs less to use because it's cut to fit.
100 Sheets15 505 M7.....\$ 9.05
1000 Sheets15 507 M7.....\$85.00

● **AMES DIE-CUT SANDPAPER**—Sheets of precut 80 Grit sandpaper, specially die cut to fit Ames sanders. Comes in packages of 100. 100 11" x 4¾" sheets.
15 322 H7.....\$10.00

● **FABRICUT SANDPAPER**—This open weave silicon carbide sanding cloth practically cleans itself. It lasts longer, cuts joint mud faster than regular sandpaper and won't clog easily. A pleasure to work with. A 12" x 20' roll is a good investment, fits most sanders.
100 Grit.....05 215 H7.....\$21.71

● **GOLDBLATT LONG - HANDED UNIVERSAL SANDER**—With turned up edges you absolutely cannot bend the sander—or scratch wall-board. An entirely new concept in universal joints makes this high quality sander much less expensive than similar tools.

With this deluxe tool you can sand anywhere in any room—walls, ceiling and wall side of ceiling angle without a bench.

This tool has exclusive Goldblatt Spring clamps to make attaching new sandpaper exceptionally fast and easy. The clamps hold sandpaper firmly to the fine rubber face of the tool. Sanding head is 9" x 4". Light bass wood handle is 48" long. Universal Sander.
15 319 M7.....\$7.50

Wooden Handle Only.
15 314 M7..... .80
Handle Attachment Only.
15 299 M7..... 1.25
Pkg. 100 sheets 80 Grit Precut Sandpaper for this tool.
(sandpaper only) 15 505 M7.....\$9.05

● **AMES UNIVERSAL LONG-HANDED SANDER**—Patented "Universal" swivel device on this sander attached to 48" handle lets you sand any part of room—including ceilings and wall side of ceiling—from the floor. Made of feather-weight aluminum alloy. 9½" long, 3⅝" wide. Two positive paper grips hold sandpaper positively against rubber pad.
15 317 H7.....\$6.90

100 sheets 80 grit die cut sandpaper for this tool.
(sandpaper only) 15 322 H7.....\$10.00

● **CORNER SANDER**—A real time and trouble-saver! 5' handle makes sanding of the toughest ceiling corners easy! Steel sanding block is 4" long, has 4½" sides. A half sheet of any standard sandpaper fits perfectly, inserts quickly.
15 320 M7.....\$7.25

Handle Only for Corner Sander.
15 324 M7.....\$2.40
Pkg. 100 sheets 80 grit precut sandpaper for this tool.
(sandpaper only) 15 505 M7.....\$9.05

HAND SANDERS

● **AMES BLOCK SANDER**—Here's a rugged block sander built for day-after day use. Sponge rubber face helps make invisible feathered joints. The lightweight aluminum handle is shaped like an I-beam for rugged strength combined with ultra-lightweight. Two clamps tighten aluminum bars to hold sandpaper. Face is 3¼" x 9¾". Weight: 11 oz.
05 441 H7.....\$3.50

● **IMPROVED HAND SANDER**—Here is the finest hand sander made—newly improved. Now, with turned up edges, you absolutely cannot bend the sander—or scratch wallboard. The 9" x 4" sponge rubber face is permanently cemented to Stainless Steel base. Goldblatt's exclusive heavy duty spring clamps hold the sandpaper firmly in place, make changing paper easy. Natural wood edger style handle makes this the most comfortable to use hand sander made.....15 316 M7.....\$3.90
Pkg. 100 Sheets 80 Grit Precut Sandpaper for this tool.
(sandpaper only) 15 505 M7.....\$9.05



LONG HANDED SANDERS

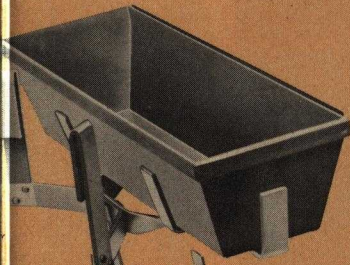
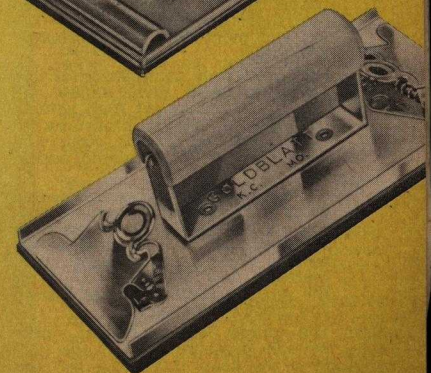
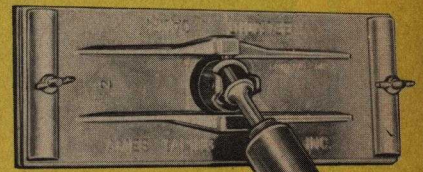

PAN HOLDER

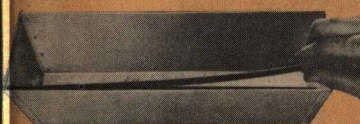
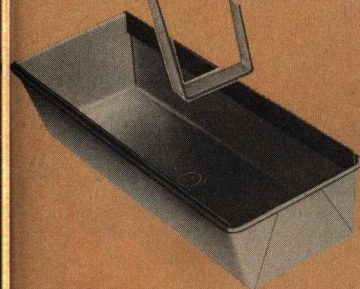

SAND-PAPER

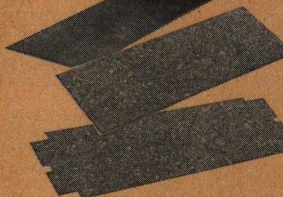

NEW!

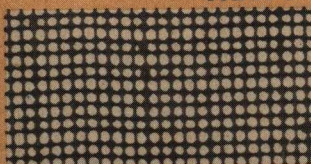

PATTERN PUMP

with PATTERN PISTOL

USE YOUR OWN COMPRESSOR

(Must deliver at least 6.5 cfm at 40 psi)



Six Volt, three-way switch puts on/off control at gun or machine.

Entire Pump Unit Lifts off in 15 Seconds.



Uses Modified Pattern Pistol Described on facing page with on/off switch and adaptor to fit 3/4" hose.

● **GOLDBLATT PATTERN PUMP**—Apply up to two gallons of texture paint every minute for complete coverage; spray continuously with this 16 gauge welded steel hopper that holds 16 gallons of material; apply materials up to 3 mils thick in one pass of the gun.

The Pattern Pump applies all water-based texture paints, simulated acoustics, latex paints, block fillers and most liquid waterproofing materials.

Use your own compressor of 1 1/2 hp or more; it must deliver 6.5 cfm at 40 psi to get high volume coverage at low air pressures, to spray textures ranging from fine sand finishes to simulated acoustics.

A three-position, low voltage switch gives you automatic operation from the gun or manual operation from the machine. This instant acting switch prevents dribble; it stops material flow when you shut off the gun, prevents "surge" when you crack the trigger.

The pump, made by us, puts enough pressure behind the material to keep it flowing but not enough to cause packing in the

hose. You can lift off the pump in 15 seconds for instant clean out and easy hauling in car trunk or pickup.

Cleans quickly, just run water through hopper and gun. The 1/2 hp gear motor drives the pump through a chain so there are no belts to wear out.

With 25' of hose you cover 1,575 sq. ft. without moving the rig. The modified Pattern Pistol supplied with your Pattern Pump has all the features described at left, except the hopper; a switch controls the pump from the gun. No hopper comes with this machine. **GUARANTEED TO SATISFY OR YOUR MONEY BACK.**

Pattern Pump Specifications: 34" high, 28" wide, 35" front to rear; hopper 20" x 20" x 26" deep, tapering to pump inlet; approx. cap. 16 gals. (2 1/4 cu. ft.); 1/2 hp 115/220V, 60 cycle, 1 phase elec. gear motor wired for 115 V; approx. pump cap. 2 gpm; 6 V 3-way on/off switch; two 2.75 x 10 solid rubber tires; 25' x 1/2" air hose; 25' x 3/4" material hose; modified Pattern Pistol; weight 129 lbs. as described above. 15 240 E5....\$540.00

TEXTURE MACHINES

CHOOSE FROM TWO SIZES



NEW!

NEW!

NEW!

- 3' Acoustic nozzle only with 3/8" tip.....09 479 E2...\$45.00
- 1/4" tip.....09 475 E2...\$ 2.25
- 5/8" tip.....09 476 E2...\$ 2.25
- 3/8" tip.....09 477 E2...\$ 2.25
- 1/8" tip.....09 478 E2...\$ 2.25
- 50' each of 3/4", 3/8" and 1/4" hose, banded.....09 474 E2...\$62.50

● **GOLDBLATT ACOUSTICAT**—With 5.9 cfm free air at 100 psi, this machine applies acoustic plaster and simulated acoustics at a rate of two to four gallons a minute. You cover up to 2000 sq. yds. in an 8 hour day, once you get the hang of it. Virtually nothing to go out of whack—engine speed controls air pressure and volume. This machine fits under a mixer so you can dump right into it. Two men easily lift it into a car, truck or station wagon.

No maintenance. Everything but rotor, stator and the pump drive and housing are standard equipment and can be replaced locally. Use up to 50' of hose, 3' acoustic nozzle supplied with a 3/8" diameter orifice. Comes complete with nozzle, 50' each of 3/4", 3/8", and 1/4" hose, banded.

Specifications: 3 hp Briggs and Stratton engine with recoil starter; 5.9 cfm at 100 psi compressor; belt idler clutch; L-3 rotor and stator pump; capacity 26 gal.; volume 2 to 4 gpm.

Acoustic Complete 13 500 E2....\$715.00

● **GOLDBLATT MULTITEX**—Applies acoustic, drywall textures, fog, splatter, sand finish, waterproofing, pool finishes and concrete wall coating. No other machine near our price applies all these finishes.

The rugged 6 hp B & S engine, working through a disc clutch rated at 12 hp, pumps one to five gpm of most materials through 75' of materials hose. The compressor delivers up to 9.0 cfm at 100 psi.

Put your machine in gear, give her full throttle to apply texture faster than you can move. Then use the disc clutch and transmission to slow down and apply fog coats. A real work horse that fits into the back of your station wagon. Comes with 75' each of 3/4", 3/8" and 1/4" hose banded. 3' nozzle with 7/8" tip included. Specifications: 6 hp Briggs & Stratton engine, 9.0 cfm at 100 psi compressor; disc clutch; 2L3 rotor & stator pump; 35 gal. hopper capacity; volume, 1 to 5 gpm.

Goldblatt Multitex 15 500 E2....\$1,150.00

PATTERN PISTOL™ WITH ELECTRIC COMPRESSOR

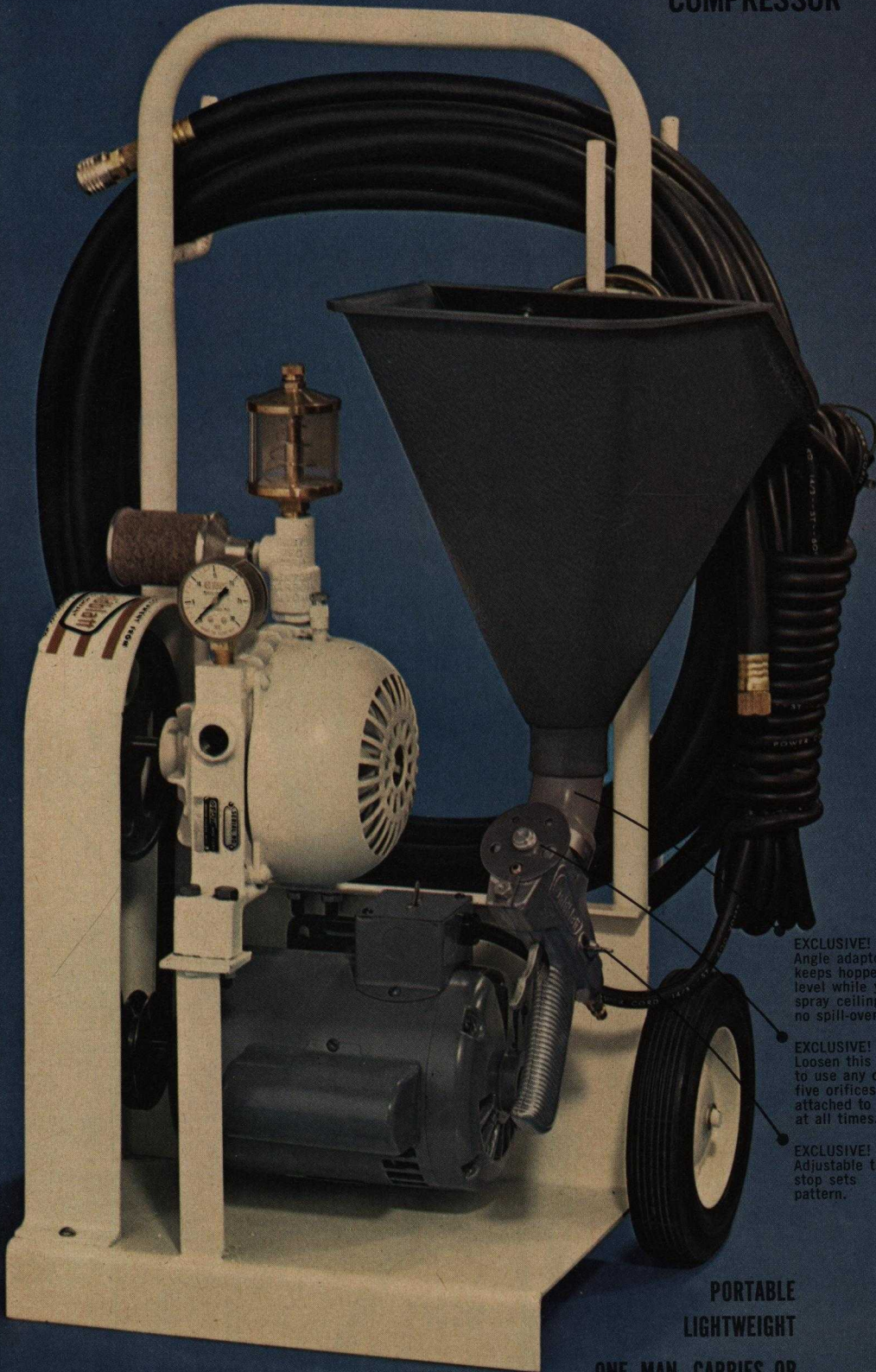

**PORTABLE
LIGHTWEIGHT
ONE MAN CARRIES OR
ROLLS IT ANYWHERE**

EXCLUSIVE!
Angle adaptor keeps hopper level while you spray ceilings; no spill-over.

EXCLUSIVE!
Loosen this bolt to use any of five orifices attached to gun at all times.

EXCLUSIVE!
Adjustable trigger stop sets pattern.

PATTERN PISTOL GUN & HOPPER

● **IMPROVED PATTERN PISTOL™ GUN & HOPPER**—The only hand gun with two interchangeable air stem nozzles to double your range of patterns and spray pressures. This gun sprays materials you couldn't touch before. A free adaptor lets you spray ceilings while you hold the lightweight plastic hopper upright.

You get two air nozzles: $\frac{1}{16}$ " and $\frac{9}{64}$ ". With the smaller, you work right up to the maximum pressure of your compressor; the larger works in the lower pressure range. You change orifices instantly with the exclusive orifice dial on the gun. It has $\frac{7}{32}$ ", $\frac{1}{4}$ ", $\frac{1}{6}$ ", $\frac{3}{8}$ ", and $\frac{1}{2}$ " orifices.

No need to disconnect your air hose to stop material flow. Set your pattern where you want it with the trigger stop—you'll return to the same texture everytime you pull the trigger. Releasing the trigger stops material flow on all but the $\frac{1}{16}$ " orifice.

Plastic hopper won't dent or break, can't rust. Rounded corners prevent material build up. It holds $1\frac{3}{4}$ gallons of material—but the fully loaded hopper is so well balanced, so light you'll feel no more weight than with other, smaller hoppers.

GUN & HOPPER ONLY (No Hose)
13 301 M5...\$68.50

GUN & HOPPER WITH 50' HOSE
13 303 M5...\$84.50

50' OF 1/2" HOSE ONLY
13 304 E5...\$18.75

TWO AIR NOZZLES FOR A WIDE SPRAY RANGE

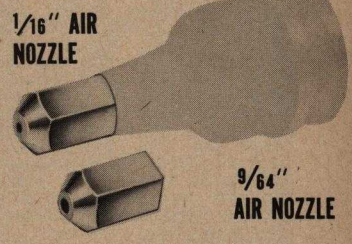

WITH COMPRESSOR

● **IMPROVED PATTERN PISTOL™**
The Improved Pattern Pistol Gun & Hopper that comes with this machine is described above. This machine is built to such rigid tolerances you can spray anything that will flow by gravity with aggregate small enough to pass through one of the orifices. Sprays mill mixes, acoustics, drywall mud, texture paints, glitter and waterproofing plus many other materials. Sprays about $\frac{1}{2}$ gallon of material a minute, depending on mix. The cool-running, 1 hp. capacitor-start electric motor drives a rotary vane compressor that produces up to 30 psi when used with $\frac{1}{16}$ " air nozzle. The entire machine is light, compact, but sturdy.

Specifications: 19" wide, 34" high, 15" front to back. Two 10 x 1.75 rubber tired wheels.

PATTERN PISTOL complete with 50' of $\frac{1}{2}$ " air hose, 25' power cable, gun and hopper, instructions. Shipping weight 108 lbs.
.....13 300 M5...\$380.00

Compressor Only—Delivers 7.0 cfm at 25 psi. With lubricator, filter and gauge (no motor, dolly, relief valve, etc.).....13 305 E4...\$84.00

CHANNEL-STUD SHEAR

GUARANTEED UNCONDITIONALLY

CUTS CLEAN

CUTS ALL SIZES OF STUD & CHANNEL



Squeeze the handles to make a three-sided, tight-locking self-riveted joint.

● **SIX-IN-ONE STUD SHEAR**—Throw away your tin snips, hacksaws, abrasive blades—you'll cut metal drywall stud and channel like butter with this new tool. This shear reduces cutting time by 75%. Your metal stud jobs will be ready for wallboard hours earlier than ever before. This shear cuts 1½", 2½" and 3½" metal stud and channel with one quick stroke of the hollow ground chrome/moly steel blade. You make each cut right on the mark without deforming the metal. No more wasted materials, burrs to cut your hands or poor fitting cuts. The 36" handle gives you so much leverage, a 4-year-old can cut channel for you. To change from cutting channel of one size to another, just slip the stud into the tool and cut, no adjustment needed. Weighs only 19 lbs., is 36" long, 6" wide.

15 804 H5...\$99.50

● **TRI-LOK PUNCH RIVETER**—Just squeeze the two 16" handles together—the tool first punches a triangular hole in the two pieces to be joined, then rolls both layers of metal together to form a tight permanent lock. No material costs! Stud and channel lock themselves together.

The triangular Tri-Lok fastening resists stress from almost any angle to make a long lasting, sturdy bond. Works in tight quarters too—fits inside the smallest stud and channel. Only 8" travel of one arm punches and locks stud and runner together—the other arm is stationary so you can make your joint right "on the money." To work near the ceiling without scaffold or stilts, just slip two short lengths of pipe over the handles.

21" long overall, weighs 5 lbs. 15 805 H5...\$54.50

HEAVY DUTY DRYWALL SCREWDRIVER

\$86.50

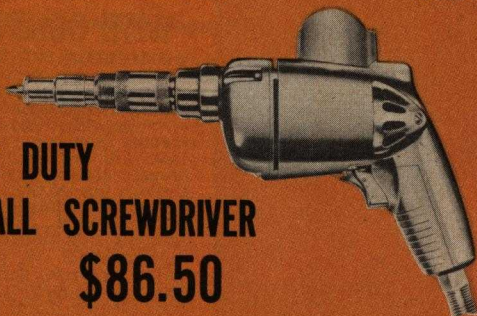

● **HEAVY DUTY DRYWALL SCREWDRIVER**—With this tool you can drive gypsum panel screws to a preset depth, then it automatically disengages, preventing marred screw heads and damaged wallboard paper. Makes driving Phillips Head self-drilling screws into metal or wooden studs practically effortless. The magnetic bit holds the screw to the tip of the driver. A removable sleeve on the depth adjustment makes it easy to reposition the bit in damaged screw heads to remove them. A reversing switch changes direction of driver

instantly. Depth is easy to adjust. Use this tool with 1" and 1½" steel studding screws and acoustical tile screws. Screw-attached wallboard, lath or backing board gives you stronger, better looking, finished walls, fewer calls back. The heavy duty Ingersoll-Rand screwdriver illustrated drives screws at 1900 rpm. It comes with a universal 115 volt AC/DC motor with reversing switch, 3-conductor, 18 gauge 10' cord and a magnetic Phillips Head bit. It is 12" long overall, weighs 4¾ lbs.

15 202 E2...\$86.50

LAYOUT LEVEL

NEW!

● **TELESCOPING LAYOUT LEVEL**—The two extruded sections of this aluminum level interlock to make a solid, accurate level up to 15' long. The spring-loaded, padded base locks the level in the plumb position so that it stands free and supports itself. Once set up, you can plumb many points in the same room without changing the setting. Has a full magnetic edge to hold it securely to metal studs, beams, door bucks, etc. Use this edge to hold the level securely while you plumb door frames or studs with both hands. Two level, eight plumb replaceable vials. If vial cases break we'll replace them Free.

6'6" to 10' Layout Level 09 468 E7...\$ 80.00

9'6" to 15' Layout Level 09 469 E7... 150.00

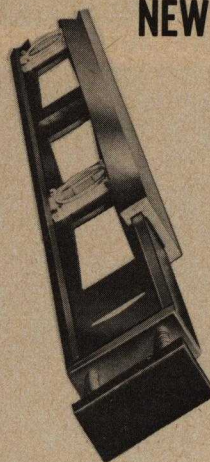

CLINCH-ON TOOL

Install a corner bead without nails in as little as 12 seconds with this tool.

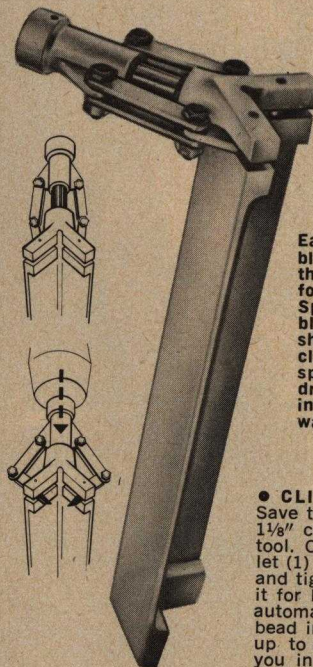

Each blow of the Mallet forces the Spring-loaded blades to shape a clinching spike and drive it into the wallboard



● **CLINCH ON CORNER TOOL**—Save time, save trouble; set 1½" x 1½" corner beads easier with this tool. One blow of the rubber mallet (1) drives the corner bead flush and tight to the corner; (2) centers it for best cement distribution; (3) automatically clinches the corner bead in place without nails. Reach up to an 8' ceiling without stilts; you install an 8' bead in as little as ten seconds as soon as you get the hang of this tool. One blow of the mallet every 4" to 6" firmly secures it to the corner. Try it. It's Guaranteed. Corner Tool and Mallet.

15 806 H5...\$49.45

Spare Parts Kit—Contains all needed parts to replace main wear items: 2 nuts, 2 bolts, 2 pins and 2 crimping teeth. 15 807 H5...\$7.50

● **RUBBER Mallet**—Black rubber 2½" x 4½" head. Ideal to use with Clinch-On tool above. 13¾" handle, weight 1¾ lbs.

02 193 H7...\$1.95



NEW!
Mallet



● **GLITTER**—Fade resistant and tarnish-proof. Our glitter reflects light better and covers almost three times more area than others—about 500 sq. ft. per lb. To apply it, you gun it onto wet acoustic plaster or texture paint with a glitter gun or texture gun. Only Glaschip is recommended for exterior application.

● **GLITTER SAMPLE CARDS**—Contains samples of all Goldblatt Glitter to help you sell the "glitter" idea to your customers. Adds profit to your jobs.
1 Sample Card.....09 350 E5...\$.95

● **SILVER GLITTER— $\frac{1}{32}$ " cut**
1 lb. can.....09 351 E7...\$ 2.00
10 lb. can.....09 353 E7...\$ 18.00
100 lb. drum.....09 355 E7...\$150.00

● **SILVER GLITTER— $\frac{1}{16}$ " cut**
1 lb. can.....09 352 E7...\$ 2.00
10 lb. can.....09 354 E7...\$ 18.00
100 lb. drum.....09 366 E7...\$150.00

● **GOLD GLITTER— $\frac{1}{32}$ " cut**
1 lb. can.....09 391 E7...\$ 2.50
10 lb. can.....09 393 E7...\$ 22.50
100 lb. drum.....09 395 E7...\$195.00

● **GOLD GLITTER— $\frac{1}{16}$ " cut**
1 lb. can.....09 392 E7...\$ 2.50
10 lb. can.....09 394 E7...\$ 22.50
100 lb. drum.....09 396 E7...\$195.00

● **BABY BLUE GLITTER— $\frac{1}{32}$ " cut**
1 lb. can.....09 381 E7...\$ 2.50
10 lb. can.....09 383 E7...\$ 22.50

● **BABY BLUE GLITTER— $\frac{1}{16}$ " cut**
1 lb. can.....09 382 E7...\$ 2.50
10 lb. can.....09 384 E7...\$ 22.50

● **MULTI-COLOR GLITTER— $\frac{1}{32}$ " cut**
1 lb. can.....09 361 E7...\$ 2.50
10 lb. can.....09 363 E7...\$ 22.50

● **MULTI-COLOR GLITTER— $\frac{1}{16}$ " cut**
1 lb. can.....09 362 E7...\$ 2.50
10 lb. can.....09 364 E7...\$ 22.50

● **RED GLITTER— $\frac{1}{16}$ " cut**
1 lb. can.....09 338 E7...\$ 2.50
10 lb. can.....09 340 E7...\$22.50

● **RED GLITTER— $\frac{1}{32}$ " cut**
1 lb. can.....09 334 E7...\$ 2.50
10 lb. can.....09 335 E7...\$22.50

● **FUCHSIA GLITTER— $\frac{1}{16}$ " cut**
1 lb. can.....09 369 E7...\$ 2.50
10 lb. can.....09 378 E7...\$22.50

● **FUCHSIA GLITTER— $\frac{1}{32}$ " cut**
1 lb. can.....09 367 E7...\$ 2.50
10 lb. can.....09 368 E7...\$22.50

● **GREEN GLITTER— $\frac{1}{16}$ " cut**
1 lb. can.....09 389 E7...\$ 2.50
10 lb. can.....09 390 E7...\$22.50

● **GREEN GLITTER— $\frac{1}{32}$ " cut**
1 lb. can.....09 387 E7...\$ 2.50
10 lb. can.....09 388 E7...\$22.50

● **ROYAL BLUE GLITTER— $\frac{1}{16}$ " cut**
1 lb. can.....09 399 E7...\$ 2.50
10 lb. can.....09 400 E7...\$22.50

● **ROYAL BLUE GLITTER— $\frac{1}{32}$ " cut**
1 lb. can.....09 397 E7...\$ 2.50
10 lb. can.....09 398 E7...\$22.50

GLASCHIP-INERT & WEATHER-PROOF—Diamond-like in effect. This inert, brilliant material is used for exterior stucco. Covers 200 sq. ft./lb. #20 size.

1 lb. bag.....09 356 E7...\$.95
10 lb. bag.....09 357 E7...\$ 6.25
50 lb. bag.....09 358 E7...\$29.75

GLITTER

ADDS VALUE, ADDS LIFE, ADDS PROFIT
TO EVERY TEXTURED CEILING—EASY TO APPLY

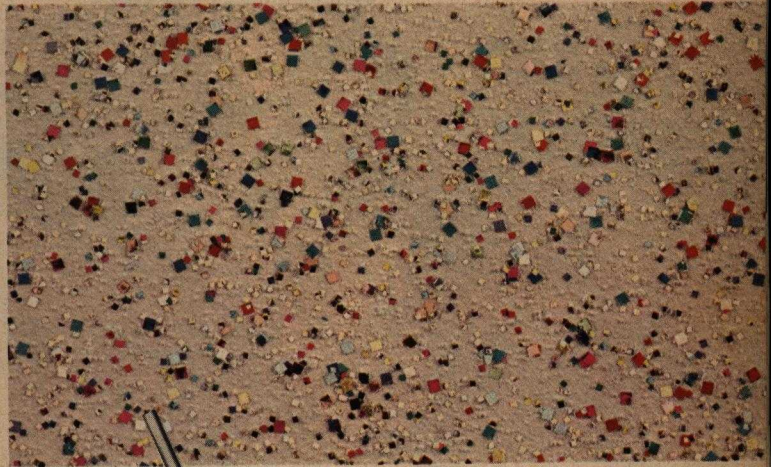

GLITTER GUNS

● **GLITTER GUN**—With this gun attached to your regular plaster gun air hose (or any other compressor of $\frac{1}{2}$ hp or larger) you can apply glitter to almost any surface. Requires 15 lb. to 30 lb. pressure. 10" curved nozzle to apply glitter to ceiling, 2" straight nozzle also included. Adjustable air valve on gun gives fine control of spray. Weight 27 ozs....13 311 H5...\$28.50

● **GLITTERMASTER GUN**—This handy spray gun is perfect to apply glitter to walls and ceilings. Needs no compressor or expensive equipment—a flick of the handle cranks out a steady flow of glitter. Sturdy, all metal construction won't rust; gears will last and last for trouble-free operation. Weighs only 1 $\frac{1}{2}$ lbs.....15 515 H7...\$11.90

ELECTRIC GUN

● **ELECTRIC CHIP GUN**—Low Pressure air driven by a squirrel cage blower applies chips evenly to seamless floors and other surfaces. Easy to carry in one hand, well balanced for easy chip applications. Hand crank and baffle in the hopper keep chips moving smoothly. Sits upright on the floor for easy filling. Won't tip. All welded steel construction. Requires 110V, 60 cycle current; weighs 7 $\frac{1}{2}$ lbs., is 17" long.
07 268 E3...\$49.50

NEW!

HAND TEXTURE TOOLS

MUD ROLLER and PAN



● **MUD ROLLER**—This heavy duty 14" professional roller with sturdy, 54" wooden handle covers large areas. A strong yoke permits heavy pressure when needed. Used with mud pan.....15 414 H7...\$12.98
Replacement Cover
15 415 H7... 7.95

● **MUD ROLLER PAN**—18 gauge galvanized steel, 24" long and 16" wide, 4" deep at well end, 2" deep at shallow end. Sturdy legs. Half-round steel handles pull up for easy carrying. Complete with expanded steel screen that covers bottom of pan. Holds 25 lb. bag of joint mud.....15 416 M7...\$13.80

● **TEXTURE BRUSH**—The fine horsehair and fibre bristles permanently fixed in hardwood base of this brush make it ideal for texturing wallboard. Bristles are 2 $\frac{1}{2}$ " long; 6" in diameter; block is 4 $\frac{1}{2}$ " in diameter with two handle holes. Fits hand comfortably or attach handle.....05 116 H7...\$3.30

● **SUPER-FLEX STAINLESS STRAIGHTEDGE**—This 23" flexible stainless steel blade is backed with a plastic handle that makes it the most useful tool we've seen in years. Use it to paint along edge, to smooth wrinkles out of wall coverings, to cut masking, to apply adhesives, to knife or smooth walls—or to knock the top off texture. You'll dream up dozens of uses for yourself.
09 467 H7...\$1.69

NEW!

DAVID WHITE LEVELS MADE IN U.S.A.

26 Power Scope!

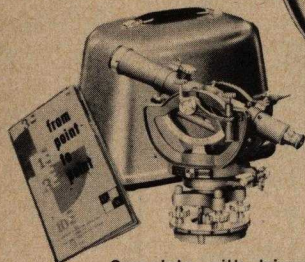

Complete with tripod, Case and Instructions



with NEW STEEL TRIPOD, PLUMB BOB & CARRYING CASE

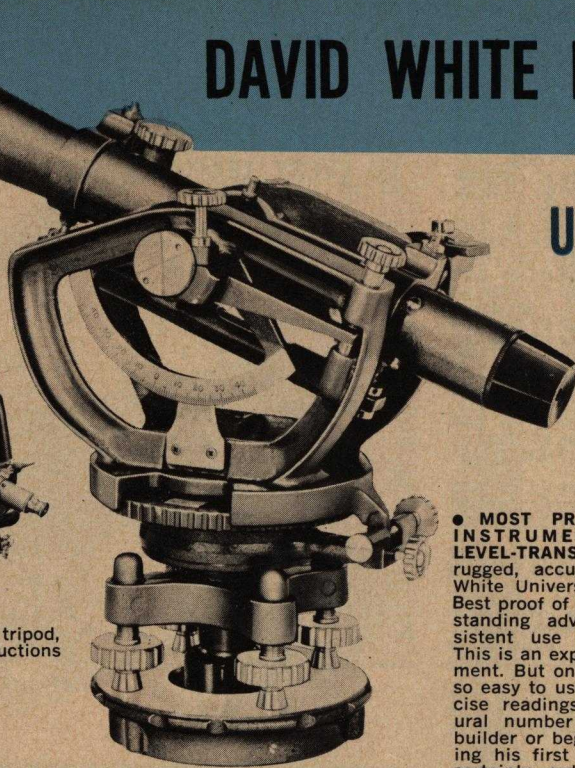

UNIVERSAL LEVEL-TRANSIT

• **MOST PRACTICAL BUILDER'S INSTRUMENT: DAVID WHITE LEVEL-TRANSIT**—This is the rugged, accurate, versatile David White Universal Level-Transit. Best proof of this instrument's outstanding advantages is its consistent use on closely-bid jobs. This is an expert's precision instrument. But on the other hand, it is so easy to use and gives such precise readings that it is the natural number one choice for the builder or beginning engineer buying his first instrument. You can certainly order this transit with confidence. It carries a written un-

conditional guarantee against any mechanical defects for a period of one year. Overall instrument weight is 11 lbs. Comes to you in a handsome, fiberglass carrying case. **SPECIFICATIONS:** 12" telescope, 26X, adjustable eyepiece, internal focusing; pressure cast, one piece standard with dual lock levers for two point alignment; double ball bearing center on lifetime lubricated inner and outer races; brass clamp and tangent screws; 3 $\frac{1}{4}$ " horizontal circle graduated from zero to 90° every 10°, vernier reads to 5 mins.; 4 $\frac{3}{4}$ " vertical arc numbered clockwise and counter clockwise from 0° to 45°, vernier reads to 5 mins.

LEVEL-TRANSIT WITH NEW WIDE FRAME ALUMINUM TRIPOD
07 135 E2...\$250.95

LEVEL-TRANSIT WITH NEW WIDE FRAME EXTENSION TRIPOD
07 136 E2...\$268.95

LEVEL - TRANSIT WITH STADIA WIRES—To order your Universal Transit with stadia wires, order any of above and add \$5.00 to price shown.

COMPASS FOR UNIVERSAL TRANSIT07 132 E2...\$17.50

LOW COST LEVEL \$78.50

• **LOW COST LEVEL**—Here's precision at a budget price. This 18 power, 10 $\frac{1}{2}$ " scope with built in sunshade focuses with either-hand rack and pinion action just like the most expensive instruments. The base levels quickly, even with gloves on. The graduated circle is dirt and moisture-proof; the trans-

parent vernier reads exact to 15 seconds. A clamp and tangent screw makes extra-fine adjustments easy. Perfect instrument for light construction work. Shipped complete with wide-frame steel leg tripod, plumb bob, fiber glass carrying case and instructions. 07 139 E2.....\$78.50

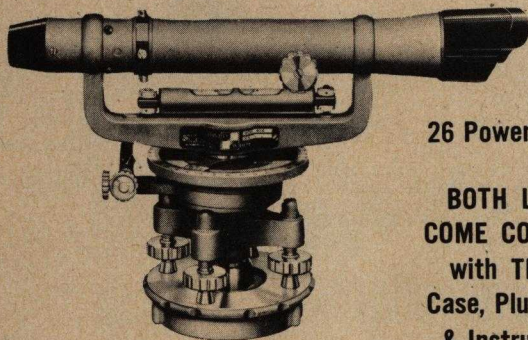

26 Power Scope!

BOTH LEVELS COME COMPLETE with TRIPOD, Case, Plumb Bob, & Instructions

12" BUILDERS DUMPY LEVEL \$190.95

• **12" BUILDER'S DUMPY LEVEL**—This fine 12" dumpy level is built to the specifications of the U. S. Department of Agriculture Soil Conservation Service. The telescope vertical supports, horizontal bar and vertical spindle are of one piece. The only adjustment necessary or possible except for telescope, is the spirit level. An instrument that can take hard use. Compare these specifications! **TELESCOPE**—Internal focusing, erecting, 12" long, dustproof; magnifying power 26 diameters; 1.357" objective with rack and pinion; eyepiece has spiral adjustment for focusing cross wires. (Coated optics) **SPIRIT LEVEL**—5" long,

ground and graduated 60 seconds. **LEVEL BAR**—Reinforced cast, with rigid telescope supports. **CIRCLE**—4-in. machine divided in degrees and engraved to quadrants with corrugated edge for setting to zero; vernier reading to 5 mins. **BALL BEARING RACE**—perfect adjustment under most severe conditions. **EQUIPMENT**—Carrying case, plumb bob, adjusting pins and instructions. 8 lbs.

12" DUMPY LEVEL WITH WIDE FRAME ALUMINUM TRIPOD
07 183 E2...\$190.95

12" DUMPY LEVEL WITH WIDE FRAME FINE EXTENSION TRIPOD
07 180 E2...\$208.95

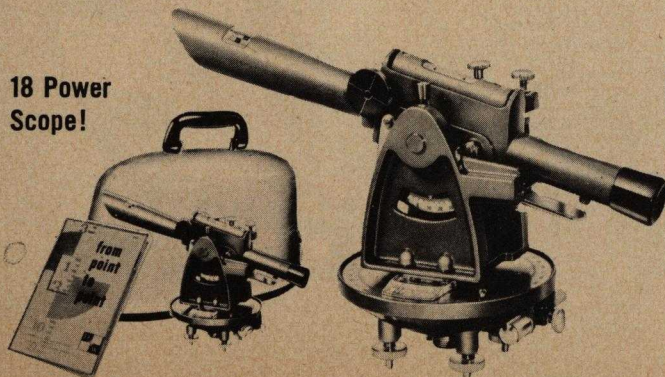

18 Power Scope!

LOW COST LEVEL TRANSIT \$129.40

• **LIGHT CONSTRUCTION LEVEL TRANSIT**—This high quality transit has all the features of expensive instruments except the price. Ruggedly built, bright optics, precision adjustments. The all-round low cost instrument for setting elevations, running curb lines, laying out landscapes, plumbing walls and uprights and a thousand other uses. Its use is almost unlimited. Bring telescope exactly level by swinging lock lever into place. Has many truly outstanding features: vertical and horizontal clamp

screws with dual micrometer adjustment by means of tangent screws, positive lock lever for alignment of telescope for accurate leveling; easy internal focusing and rugged, pressure-cast construction. A tremendous value, this is the transit-level you need for any job. Instructions and Tripod included, as well as plumb bob and carrying case. 18 power scope.

LIGHT CONSTRUCTION LEVEL TRANSIT WITH TRIPOD
07 425 E2...\$129.40

BOTH LEVELS COME COMPLETE WITH
Hardwood Case, Plumb Bob, & Instructions

BOSTROM-BRADY LEVELS

MADE IN
U. S. A.

CONTRACTORS LEVEL

ONLY
\$107.00

with
aluminum
rod & target,
plumb bob &
hardwood
case

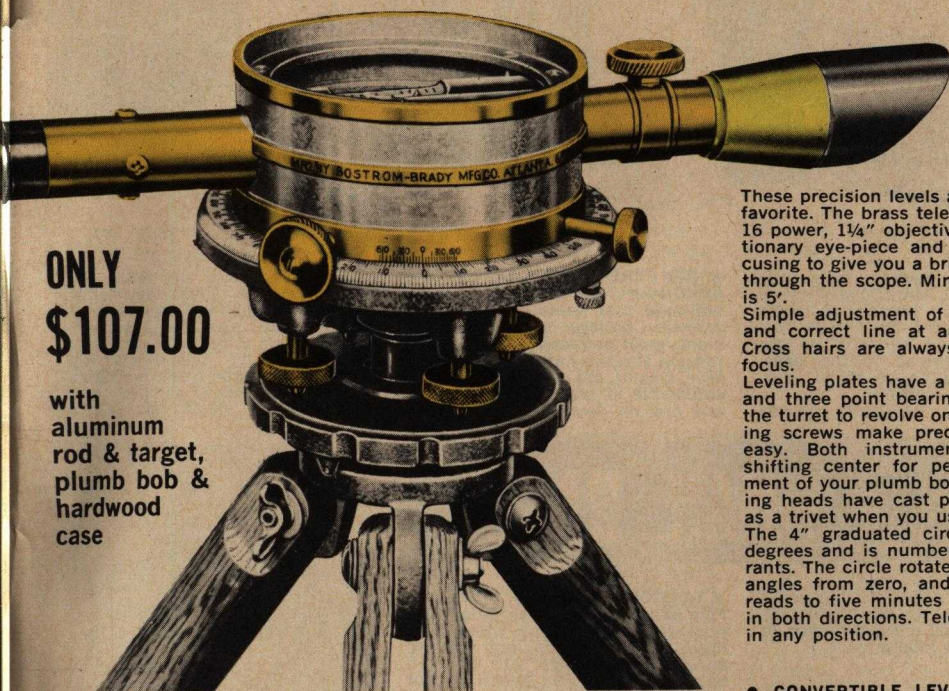

● **CONTRACTOR'S LEVEL**—The precision instrument used to lay-out building sites, drainage systems, grade lots, align foundations, drives and fences. Complete with 5' split-leg reinforced hardwood tripod with metal-tipped pointed feet;

9' aluminum extension rod and target (07 744 E2); hardwood carrying case with leather straps, plumb bob and complete instructions. Shipping weight, 18 lbs.

07 104 E2...\$107.00

CONVERTIBLE LEVEL

ONLY
\$137.00

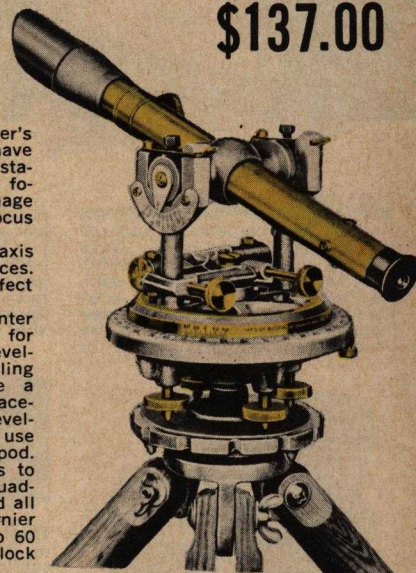

These precision levels are builder's favorite. The brass telescopes have 16 power, 1 1/4" objectives with stationary eye-piece and internal focusing to give you a brilliant image through the scope. Minimum focus is 5'.

Simple adjustment of optical axis and correct line at all distances. Cross hairs are always in perfect focus.

Leveling plates have a steel center and three point bearing plates for the turret to revolve on. Four leveling screws make precise leveling easy. Both instruments have a shifting center for perfect placement of your plumb bob. The leveling heads have cast points to use as a trivet when you use no tripod. The 4" graduated circle reads to degrees and is numbered in quadrants. The circle rotates to read all angles from zero, and the vernier reads to five minutes and 0 to 60 in both directions. Telescopes lock in any position.

● **CONVERTIBLE LEVEL**—Has all the needed features listed above, plus everything required of a quality transit. For level work, the instrument rests on two wyes. A vertical arc and index reads vertical angles. A clamp and tangent locks the transit in any position. The all-around instrument for setting elevations, running curb lines,

laying out landscapes, plumbing walls and uprights. Complete with 5' split-leg reinforced hardwood tripod with metal-tipped pointed feet; 9' aluminum extension rod and target (07 744 E2); hardwood carrying case with leather straps, plumb bob and complete instructions. Shipping weight, 20 lbs.

07 105 E2...\$137.00



WATER LEVEL



● **WATER LEVEL**—Used wherever extreme accuracy is required. Very convenient on such work as ornamental plastering. Made of fine quality rubber tubing. 50' long complete with two 2" pyrex glass tubes07 176 H7...\$7.95
Extra Glass Tubes
07 177 H7...\$.65

● **LEVELALL**—Get perfect readings with this new kind of water level. With the LEVELALL, one man finds level points as quick as he can make a pencil mark! No sighting; no signaling. Works around corners. Foolproof for batter boards, footings, foundation forms, sills, lintels and ceilings. Complete with sturdy metal carrying case, fine vinyl polychloride tubing filled with Level-Flo Fluid, plated shut-off valves, threaded mounting

brackets, extra fluid and easy-to-follow instructions.

STANDARD LEVELALL—50' Tube and extra pint of fluid

07 171 H7...\$10.75

DELUXE LEVELALL—75' Tube and extra qt of fluid 07 172 H7...\$13.75

LONG LEVELALL—100' Tube and extra qt of fluid 07 173 H7...\$16.95

Extra quarts of Special Level-Flo Fluid for use in Levelalls

07 174 H7...\$ 1.25

RODS & TARGETS

● **ALUMINUM RODS AND TARGETS**—Won't warp, twist or rot! Hollow extruded aluminum rods cost less, weigh less, last longer, but are just as accurate as bulky wooden rods—and work smoothly in any weather. Made in two sections 1 1/2" wide, 7/8" deep, 9' rods close to 5'; 13' rods close to 7'. Targets are flat sheet steel 4 3/4" in diam. All fittings are rust resistant. Verniers on rods graduated to 1/8" read to 1/4".

Rods graduated in Feet, Inches and Eighths.

9' Rod & Target 07 744 E2...\$25.00

13' Rod & Target 07 746 E2... 32.00

● **WOOD RODS AND TARGETS ONLY**—Made of light, strong magnolia wood that won't warp. Each section highly polished, 2 1/4" x 2 1/4" x 5'. Graduations are large, easy to read. Locks in any position with internal lock. Reversing die-cast 6" target is curved to prevent reflections, clamps easily to the rod. Foot numbers in red, inches in black. 9' 6" Two-Section (inches and eighths)07 741 E2...\$15.40

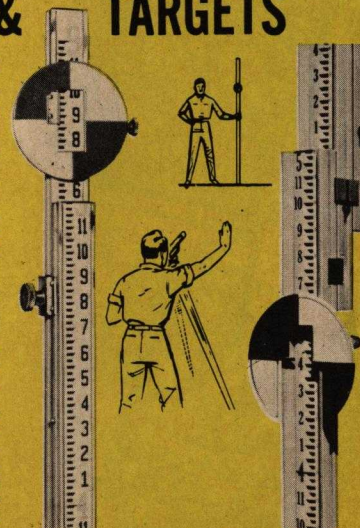

ALUMINUM ROD

Won't warp, rot or twist.

WOODEN ROD

Magnolia wood rod has internal lock.

NAIL POUCHES, CARPENTERS APRONS

These leather goods are the finest we have ever seen. Buy them with confidence; they are guaranteed to satisfy or your money back.

LEATHER
TOOL
AND
NAIL
POUCHES



TWO BAG
APRON
FOR
OFF-THE-
HIP USE

● **12-POCKET EFFICIENCY APRON**—Used by carpenters, drywall hangers, lathers and others. Gives free leg action for climbing, bending, kneeling. Nails won't spill. Has two 8" x 9", two 4½" x 6" flared pockets, two wide hammer loops, two small tool pockets, two pencil sheaths, four nail-set or

punch slots, center tape rule pocket. Pockets are double stitched for long wear, riveted at stress points. Web belt 2½" wide adjusts up to 46" waist; it is both riveted and sewed to the bags. Apron hand-made of tough, durable moccasin cowhide.

09 128 H8... \$14.25

● **OFF-THE-HIP CARPENTER'S APRON**—Here's a combination of nail and tool pouches that many workmen believe is the most efficient, most comfortable made. The reason: the two bags plus the steel tape holder are each individually adjustable to your comfort. Position one bag on each hip for easy ac-

cessibility to tools and nails, yet keep them out of the way when bending or kneeling. The two bags have the same pocket arrangement as the apron at left, but each has its own tunnel loop. Bags are soft, pliable, hand-made moccasin cowhide, double-stitched and riveted. 09 867 H8... \$15.75



NAIL BAGS

These leather goods are the finest we have ever seen. Buy them with confidence; they are guaranteed to satisfy or your money back.

● **TWO-POCKET NAIL BAG**—Has one 10" x 11" "bellows flared" pocket that stays open, one 6" x 5" flared top pocket. Rip-proof, rivet-reinforced steel stitching. Made of heavy-grade, brown moccasin cowhide. Wide tunnel belt loop 09 442 H8... \$5.15

● **DELUXE NAIL BAG**—Large 10" x 11" "bellows flared" pocket that's easy to reach into, plus handy hammer loop. Rip-proof, rivet-reinforced steel stitching. Made of heavy pearl gray chrome leather. Wide tunnel belt loop. 09 440 H8... \$4.50

● **ALL PURPOSE NAIL BAG**—Like the 09 440 H8 on the facing page, this bag has a large 10" x 11" bellows-type flared nail pocket. Steel staple rip-proof stitching, capped rivets and wide tunnel belt loop make this bag exceptionally sturdy. Lasts for years. Made of supple but strong pearl gray chrome leather 09 846 H8... \$4.15

● **DELUXE NAIL BAG**—Has 10" flared pocket, 4" x 6" pouched pocket, two nail set slots, all leather-bound; also 3" x 5" tool pocket and hammer loop. Bag is moccasin leather, saddle stitched and riveted.
Left Side Hammer Loop 09 444 H8... \$6.25
Right Side Hammer Loop 09 445 H8... 6.25

● **14-POCKET CANVAS APRON**—Five nail pockets, seven small tool pockets in quality 8-oz. white duck make this an efficient canvas apron. The 24" wide, 21" long bib has a deep pad and pencil pocket chest pocket. Double tier of pockets at waist has a flared nail pocket, plus a hammer loop on each side. Criss cross shoulder straps for secure fit. Made with copper capped rivets and chrome "D" ring grommets for long life. 09 897 H8... \$2.25



NAIL BAG & BELT



● **WEB PISTOL BELT**
Adjusts instantly with hook-in fastener. Two inches wide, it fits up to a 44" waist. 04 452 H8... \$2.45

● **LATHER'S PAL LEATHER NAIL BAG**—Soft, heavy chrome tanned split cowhide, stitched with linen cord drawn through wax. Smooth rivets on both sides can't scratch hands. 14½" x 10". Pocket depth, 9" 04 451 H7... \$3.25

TOOL BAGS & POUCHES



HEAVY DUTY TOOL BAGS



• **LOW COST TOOL BAG**—A perfect second bag. Made of heavy duty, long-wearing canvas. Two steel dowels and a board bottom hold the bag in shape. 20" long, 6" wide, 13" high with sturdy riveted, leather handles and straps. Extremely light. Chrome buckles. 09 500 H7....\$4.25

• **HEAVY DUTY TOOL BAGS**—Built on a 12 gauge steel frame, these canvas tool bags are light but rugged. Seams are all lock-stitched with waxed linen thread—they won't rip! Handles, billets and buckles are riveted to the steel frame. Both styles have a waterproof board bottom as abso-

lute protection against water. Each has inside pocket for small tools.

STANDARD CANVAS TOOL BAG—			
Length	Depth	Stock #	Price
16"	14"	09 216 H7	\$7.70
18"	15"	09 218 H7	\$8.00
20"	16"	09 220 H7	\$8.40
24"	18"	09 224 H7	\$9.00

Leather Reinforced

WITH 3" LEATHER REINFORCING			
Length	Depth	Stock #	Price
18"	15"	09 118 H7	\$12.75
20"	16"	09 120 H7	\$13.45
22"	17"	09 122 H7	\$14.15

DRYWALL TOOL POUCHES

• **NAIL BAG-TOOL HOLDER**—Holds nails and tools in one lightweight unit. Fits over your belt. Pouch is rugged, but medium-soft leather stitched and riveted for maximum strength and usefulness. It holds nails, a measuring tape, drywall hammer, utility knife and hole saw. Weight, 7 1/2 ozs. It is 7 1/2" wide, 6 1/2" deep.....05 175 H7....\$4.95

• **FOUR POCKET ALL PURPOSE POUCH**—Made with a permanently pouched 6" x 6 1/2" inside pocket, 3 outside pockets 2" wide, two open-end screwdriver slots, a hammer loop, "T" bar tape chain and a harness hook, this tool holder is double saddle stitched top grain cowhide reinforced with brass rivets to last for years. Only 6" x 9" overall, it is made for men who want a compact kit to hold a maximum of tools. 09 813 H8....\$6.30

• **STEEL HAMMER LOOP**—This 2" x 2" plated steel loop is secured between 4 1/2" x 7" leather laminations. This is the easiest-to-use hammer loop we know of—and that's what makes it most popular among men who swing a hammer for a living.....09 822 H8....\$1.96

• **BELT TOOL HOLDER**—This handy leather tool holder slips over your regular belt to put seven small tools at your finger tips. Has four small tool slots, a hammer loop, a small tool snap and a swing "T" tape chain. Four belt slots distribute weight evenly. 09 828 H8....\$1.69

BELT—\$2.45

• **WEB PISTOL BELT**—This snap-on type pistol belt is easy to put on or take off. Adjusts instantly with hook-in fastener. Two inches wide, it fits up to a 44" waist. Ideal for all tool holders, nail bags. 04 452 H8....\$2.45

• **SADDLE LEATHER NAIL BAG—TOOL HOLDER**—Beautifully hand made of heavy top-grain natural color saddle leather. Only 8" wide, 9 1/2" deep, yet it holds all the tools you use: 2" x 2" chrome steel "U" loop takes hammer instantly, holds it snugly; pencil pocket, 2 cutting knife sheaths, extra pocket for ridged rule or tool; all around cutter pocket; steel tape holster; sharpening stone pocket; tapered slot for saw. Wide tunnel belt loop takes wide army pistol belts. Gusset sides give permanent shape. Reinforced puncture-proof bottom with stress points riveted. 05 178 H8...\$6.50

• **IMPROVED DRYWALL TOOL POUCH**—Now made of a heavier gauge of perfect top grain leather for longer wear, to take even harder abuse than ever before. Holds the tools you use most often: a big belt loop; wide strong hammer loop; two knife scabbards; pencil holder. Also holds an All-Around Cutter. Loops are riveted so they won't come apart. Your work goes faster because your tools are at your fingertips. 05 176 M7....\$4.80

These leather goods are the finest we have ever seen. Buy them with confidence; they are guaranteed to satisfy or your money back.

• **FLAT STYLE DRYWALL TOOL POUCH**—An 11 x 10" heavy duty leather drywall pouch with a wide tunnel belt loop for comfort. Has separate pockets for pencil, two cutting knives, (or box rule), all around cutter, tape rule pouch, open-end utility saw pocket and a slot for a sharpening stone. The kit fits flat to your side in use, keeps all tools snugly in place. Hand stitched and rivet-reinforced for long life.09 870 H8....\$7.35

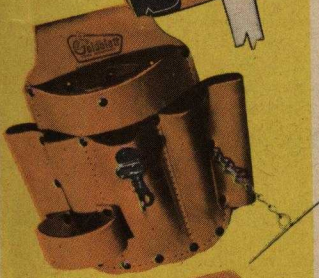

Steel Hammer Loop

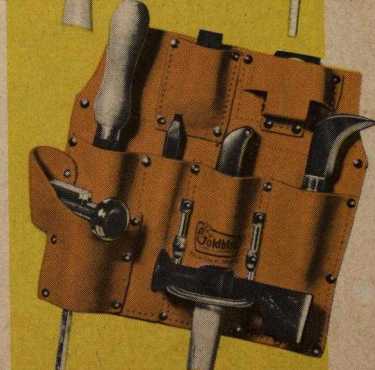
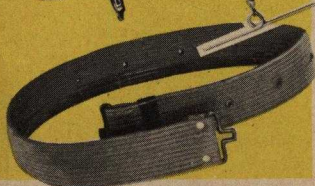

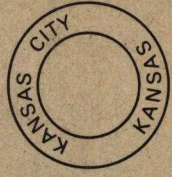
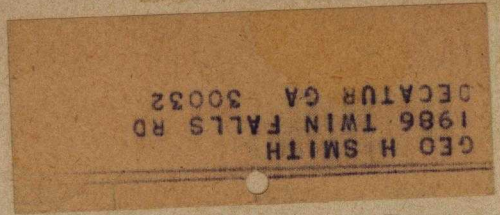

GOLDBLATT tool co.

511 OSAGE, KANSAS CITY, KANSAS 66110

RETURN REQUESTED

subsidiary of Bliss & Laughlin Industries



● **OLD PRO BUTTERING TROWEL**—The first choice of most tilers because it is the finest forged buttering trowel made today. Carefully and precisely taper ground for flexibility and balance. Maple handle with steel ferrule. Blade is 7" long, 4 3/8" wide at heel
09 341 M7...\$3.00

● **OLD PRO CROSS JOINT TROWEL**—Carefully forged from a single billet of high carbon steel selected for this trowel. Must be precisely tempered and ground for flexibility and balance. Maple handle with steel ferrule. 4 3/4" long, 1 3/4" wide at heel.....09 345 M7...\$1.90

● **OLD PRO GAUGING TROWEL**—Same rugged, long wearing construction as other Old Pro trowels, with the same comfortable, attached-to-stay-on handle. 7" long, 3 1/8" wide at heel. 09 343 M7...\$3.00

● **OLD PRO DUCK BILL TROWEL**—A necessity for insulation workers. An exceptionally fine, difficult-to-make, but made right forging. One piece. Maple handle with steel ferrule. 10" long, 2" wide at heel.....09 344 M7...\$3.00

POINTING, MARGIN, & GAUGING TROWELS

● **OLD PRO MARGIN TROWELS**—One piece forgings of the very finest high carbon steel; tough but flexible. Each blade is precisely taper ground and finished by hand to get just right flexibility and balance that pleases the most finicky

tool users. Steel ferruled maple handles stay put. Tradesmen who use professional tools always prefer Goldblatt margin trowels.
5"x1 1/2" Blade.....09 331 M7...\$1.90
5"x2" Blade.....09 332 M7...\$1.90
8"x2" Blade.....09 333 M7...\$2.70

● **OLD PRO POINTING TROWELS**—Pointing trowels have to take it. These do. One piece forged trowel steel from tip to tang. They flex right, hang right, balance right because each trowel is individually taper ground by experienced crafts-

men who know how a trowel must be made. Handle is fine maple held permanently in place with a steel ferrule.
4 1/2" Blade.....09 321 M7...\$1.90
5 1/2" Blade.....09 322 M7...\$1.90
7" Blade.....09 323 M7...\$2.50

**BOTH TROWELS
AVAILABLE IN THREE SIZES
ONE-PIECE CONSTRUCTION**

